

# HEAVY OFF ROAD

TEMPERATURE CONTROL PRODUCTS



1-800-806-5312

[www.apairinc.com](http://www.apairinc.com)



# VISIT US AT

Dealer Sign In:    Stay logged in



**AG - OFF ROAD - TRUCK**  
Air Conditioning Parts and Supplies

Toll Free: 1-800-806-5312  
**Dealer Login**

[Home](#) | [Contact](#) | [Links](#) | [Automotive](#) | [Agricultural](#) | [Heavy Off Road](#) | [Semi Tractor](#) | [Miscellaneous](#) | [Technical](#) | [Warranty>Returns](#)

## Model Search

Find Your Model



805 13TH STREET NORTH | HUMBOLDT, IA 50548 | 1-800-806-5312

### AUXILIARY & UTV Heaters

Many New Heaters!

[Click Here For Catalog](#)

### Radiators

Ag, Off Road, Truck, Auto

### AP "Air Combs"

Available in 12", 24", 36" & 48"

### Blower Motors

Ag, Off Road, & Truck

### Cab Kits & Interior Components

[Click Here For Catalog](#)

### L.E.D. Lights

Replacement Lights & Light Bars

**NEW**

### Oil Coolers

Heavy Duty Applications

[Click Here To View Flyer](#)

## Part Search

Find Your Part

- [A/C Fittings](#)
- [A/C Hose](#)
- [A/C Service Tools](#)
- [Air/Brake Hose](#)
- [Belts](#)
- [Blower Fans/SPAL](#)
- [Blower Motors](#)
- [Cab Kits](#)
- [Cab Products/Filters](#)
- [Charge Air Coolers](#)
- [Compressor Clutches](#)
- [Compressor Components](#)
- [Compressor/Conversion Kits](#)
- [Compressors](#)
- [Condensers](#)
- [Engine Fans/Clutches](#)
- [Evaporators](#)
- [Expansion Valves](#)
- [Freon](#)
- [Heaters, Heater Cores](#)
- [Lights/HD LED](#)
- [Oil Coolers](#)
- [Oil, Flush and Dye](#)
- [O-Rings, Gaskets](#)
- [Quick Coupler Fittings](#)
- [Radiators](#)
- [Rec Driers/Accumulators](#)

- Full Heavy Off Road, Agricultural, Semi Tractor, Automotive & UTV Catalogs
- Dealer Login/Online Ordering
- Model Specific Parts Lookup
- OEM Cross References for easy parts lookup
- Refrigerant & Oil Specifications Available by Application
- Technical Information
- Featured Products Section
- Live Catalog & Web Updates

VISIT US @ WWW.APAIRINC.COM



**WWW.APAIRINC.COM**

**FULL LINE OF PARTS FOR**

**AG**



**AGCO/Allis  
Bobcat  
Case/IH  
Caterpillar  
Claas  
Fendt  
Ford/New Holland  
Gleaner  
Hesston  
John Deere  
Krone  
Kubota  
Massey Ferguson  
McCormick  
Steiger  
Versatile**

**OFF ROAD**



**Bobcat  
Case/IH  
Caterpillar  
Dressta  
Fiat  
Gehl  
Hitachi  
Hyundai  
JCB  
Kobelco  
Komatsu  
Lincoln  
Link-Belt  
Terex  
Volvo**

**TRUCK**



**Chevy/GMC  
Dodge/Sprinter  
Ford/Sterling  
Freightliner  
Intl/Navistar  
Kenworth  
Mack  
Peterbilt  
Volvo/White  
Western Star**

**VISIT US @ WWW.APAIRINC.COM**

**1-800-806-5312**



# BOBCAT

## Blower Motors

BOBCAT

### SKIDSTEER

Models: A300, S100, S205, S550, S570, S590, S650, S850, T190, T190G, T320, T590, T630, T650, T750, T770, T870

Part # **BM20022**



### SKIDSTEER

Models: 751-963, A220, A300, S130-S300, T140-T30

Part # **BM200331**



### EXCAVATOR

Models: E35, E42, E45, E50, E55

Part # **BM3530**

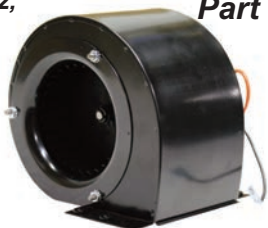

### SKIDSTEER

Models: 751-963, A220, A300, S130-S300, T140-T300

Part # **BM3535**



### EXCAVATOR

Models: E35, E42, E45, E50, E55

Part # **BM3536**

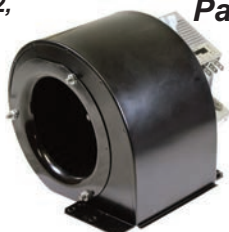

### EXCAVATOR

Models: 331, 331E, 337, 341

Part # **BM3652**



### EXCAVATOR

Models: 331, 331E, 337, 341

Part # **BM36521**



### EXCAVATOR

Models: 442, 444, ZX125, ZX75

Part # **BM4005**

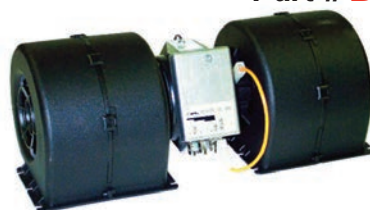

### SKIDSTEER

Models: S205, S650, S850, T320, T630, T190, T306

Part # **BM4015**

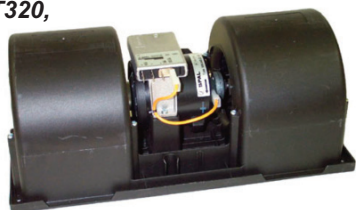

### EXCAVATOR

Models: E61, E63, E80, E85

Part # **BM4110**



### SKIDSTEER

Models: A300, S100-S850, T190, T190G, T320, T590, T630, T650, T750, T770, T870

Part # **BM4112**



### Part # **BW210**

SKIDSTEER



### Part # **BW211**

SKIDSTEER





# BOBCAT

## Compressors

BOBCAT

SKIDSTEER

**Seltec TM-13HD**

Models: S150,  
S205, T180, S160,  
S185, T190,  
T190G

Part # **506-7950**



TELEHANDLER

**12V V5 Compressor**

Models: T2866

Part # **502-007**



EXC./SKID

**Sanden SD5H11**

Models: 5600,  
5610, E32, E35,  
E42, E45, E50,  
E55, S550,  
S570, S590,  
S630, S650,  
T550, T590,  
T630

Part # **509-3971**



TOOLCAT

**OE Sanden SD5H11**

Models: 5600

Part # **509-3970**

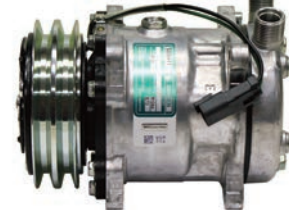

EXCAVATOR

**Aftermarket Sanden SD5H11**

Models: E35, E42,  
E45, E50, E55

Part # **509-397123**



EXCAVATOR

**OE Sanden SD5H11**

Models: E35, E42,  
E45, E50, E55

Part # **509-39712**



SKIDSTEER

**OE Sanden SD5H11**

Models: S550,  
S570, S590, T590

Part # **509-3975**



SKIDSTEER

**12V Sanden Compressor**

Models:  
S450-S850,  
T630-T870

Part # **509-39716**



SKIDSTEER

**Aftermarket Sanden SD5H11**

Models: S550,  
S570, S590, T590

Part # **509-39753**



**4.92" Clutch with 12V 2 Wire**

Models: 864,  
873, A300,  
S150, S160,  
S175, S185,  
T190, T190G,  
T200

Part # **600-6687**



EXC./SKID

**Seltec TM-08**

Models:  
331, 331E  
335, 337,  
341, 430,  
435

Part # **506-7646**



EXC./SKID

**Seltec TM-08**

Models:  
331, 331E,  
335, 337,  
341, 430,  
435, 773,  
864, 873,  
S150-S330,  
T190-T320

Part # **506-767**



**Fitting Repair Kit**

Part # **451-1177K**



**1-800-806-5312**



# BOBCAT

## Condensers

BOBCAT

### SKIDSTEER

Models: 864, A300, S250, S300, T200, T300, T320

Part # **400-9901**



### SKIDSTEER/EXCAVATOR

Models: 430, 435

Part # **400-9902**



### SKIDSTEER

Models: S150, S160, S175, S185, S205, T190, T190G

Part # **400-9903**

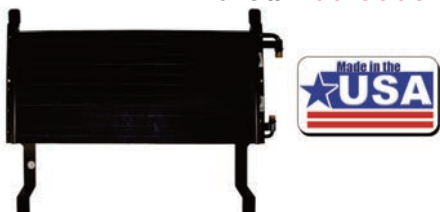

### EXCAVATOR

Models: 331, 331E, 335, 337, 341

Part # **400-9904**



### SKIDSTEER

Models: 773, S185, T180, T190, T190G

Part # **400-9905**



### SKIDSTEER

Models: S550, S570, S590, S650, T590, T630, T650

Part # **400-9906**



### SKIDSTEER

Models: S750, S850, T750, T770, T870

Part # **400-9907**



### EXCAVATOR

Models: E42, E45, E50, E55

Part # **400-9908**



### SKIDSTEER

Models: A300, S220, S250, S300, S330, S770, T250, T300, T320

Part # **400-9910**



### EXCAVATOR

Models: 442, 444, ZX125, ZX75

Part # **400-9912**



### Universal - Parallel Flow Condensers

High Efficiency  
Multi-Flow  
Condensers  
available in  
different sizes!

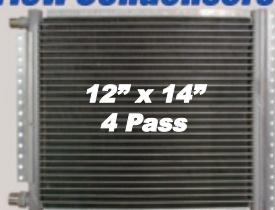

Part # **4-12142**

### CONDENSER FAN

Models: 430, 435, 453C, 453D, 453F

Part # **FA924**





# BOBCAT

## Evaporators/Expansion Valves

### EXCAVATOR

Models: 331, 331E,  
335, 337, 341

Part # **590-63006**

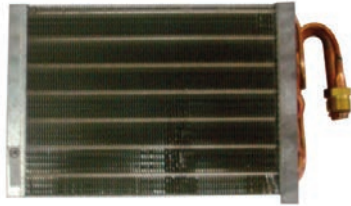

### EXCAVATOR/SKIDSTEER

Models: 331,  
331E, 335, 337,  
341, 430, 435

Part # **590-63007**

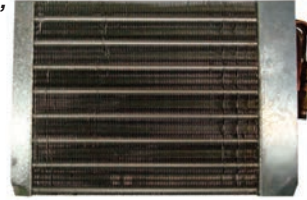

### SKIDSTEER

Models: 864, A300,  
S185, S220, T190,  
T190G, T200

Part # **590-63008**

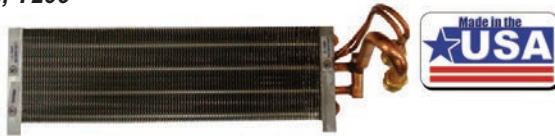

### SKIDSTEER

Models: S185,  
S205, T190, T190G,  
T300, T320

Part # **590-63010**



### SKIDSTEER

Models: S550,  
S570,  
S590,  
S650,  
S750, S850,  
T590, T630,  
T650, T750,  
T770, T870

Part # **590-63020**



### SKIDSTEER

Models:  
S450-S850,  
T590,  
T630,  
T650,  
T750,  
T770,  
T870

Part # **590-63020K**

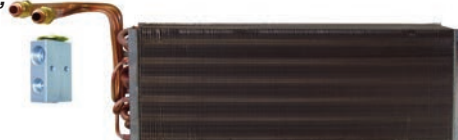

### EXCAVATOR

Models:  
442, 444,  
ZX75,  
ZX125

Part # **590-63035**

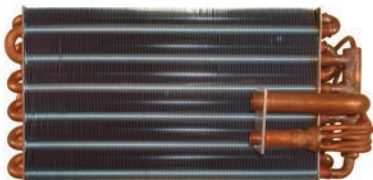

### HEATER CORE

Models:  
S450,  
S550,  
S570,  
S750,  
T630,  
T870

Part # **590-63228**

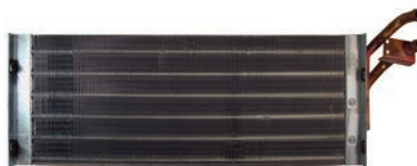

### EXPANSION VALVE

Models: 331-341,  
430, 435, 864,  
S150-S850,  
T140-T870,  
5600, 5610,  
E50, E55

Part # **903-700**



### EXPANSION VALVE

Models: 442, 444,  
ZX75, ZX125

Part # **903-711**



### EXPANSION VALVE

Models: E35-E55

Part # **903-850**



### EXPANSION VALVE BRACKET

Models: E50, E55

Part # **451-11985**





# BOBCAT

## Heater Valves

### SKIDSTEER

Models: S450,  
S590, T320,  
T590, T630,  
T650, T770, T870



Part # **570-615**

### EXCAVATOR

Models: E65,  
E80, E85



Part # **570-860**

## Fittings/O-Rings

### Quick Clip A/C Hose Crimping Tool

Allows for an Easy and Quick  
Assembly of Fittings on Hose

Part # **530-8766**



### Quick Clip Fitting Kit

O.E STYLE BOB-  
CAT FITTINGS

Part # **461-300K**



### O-Ring Kit

Models: 331-883,  
A220, A300,  
S130-S330,  
T140-T320



Part # **530-6300**

## Receiver Dries/Accumulators

### EXCAVATOR

Models: 442,  
444, ZX75,  
ZX125



Part # **800-114**



### EXCAVATOR

Models:  
E63, E85, E55W,  
E60, E62, E80



Part # **800-1172**



### SKIDSTEER/EXCAVATOR

Models:  
E32, E35, E42,  
E45, E50, E55,  
S650, S750,  
T550, T590,  
T630, T870,  
S450, S770



Part # **803-312**



### SKIDSTEER/EXCAVATOR

Models:  
331-341,  
430, 435,  
864, 883,  
S150-S850,  
T200-T870,  
5600, 5610



Part # **803-323**



BOBCAT



## Switches/Electrical

### 3 Speed Blower Switch

Models: 5600,  
A300, S185,  
S220, S550,  
S570, S750,  
T190, T190G,  
T300, T870

Part # **205-103**



### Rocker A/C Switch

Models: S185,  
S205, S450,  
S750, T300,  
T320, T870,

Part # **206-744**



### Thermostatic Switch

Models:  
E63, E80, E85

Part # **210-929**



### Thermostatic Switch

Models: 331, 331E,  
337

Part # **210-948**



### Electronic Temperature Sensor

Models: 5600,  
5610, S205, T320

Part # **210-9545**



### Electronic Thermostatic Switch

Models: 331, 331E,  
335, 337, 341, 430,  
435, 5600

Part # **210-957**

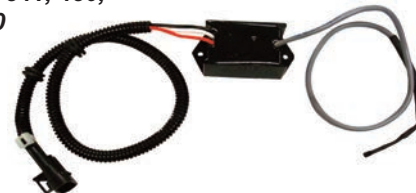

### Electronic Thermostatic Switch

Models:  
S450-S850,  
T590, T630,  
T650, T750,  
T770, T870

Part # **210-9574**



### Electronic Thermostatic Switch

Models: 331,  
331E, 335, 341,  
430, 435, 864,  
A300, S150, S160,  
S185, S205, S220,  
S300, T190,  
T190G, T200,  
T320

Part # **210-958**



### Binary Switch

Models: 5600, 5610,  
864, A300,  
S150-S850,  
T190-T870

Part # **220-1028**



### Binary Switch

Models: 864, A300,  
S150-S850,  
T190-T870

Part # **220-1030**



### Low Pressure Switch

Models: 331, 335,  
337, 341, 430, 435,  
5600

Part # **220-3010**



### Blower Speed Resistor

Models: E55W, E60,  
E62, E63, E80, E85

Part # **220-605**

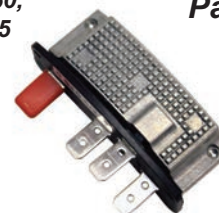



# BOBCAT

## Switches/Electrical

### Blower Speed Resistor

Models: E35, E42, E50, E55

Part # **220-607**



### Blower Speed Resistor

Models: S650, S850, T300, T320, T630, T870

Part # **220-619**



### Blower Speed Resistor

Models: E35-E55

Part # **220-627**



### OE Blower Motor Harness

Models: 751G, 773G, 863, 873, 963G, S130, S150, S160, S175, S185-S330, T140-T320

Part # **110-200331**



## Oil Coolers

### EXCAVATOR

Models: 430, 430D, 430G, 435, 435D, 435G

Part # **5-9950**

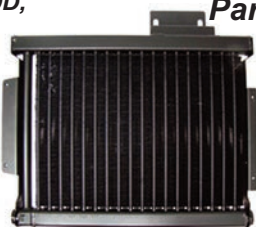

### SKIDSTEER

Models: S150, S160, S175, S185, S205, S220, T180, T190

Part # **5-9951**

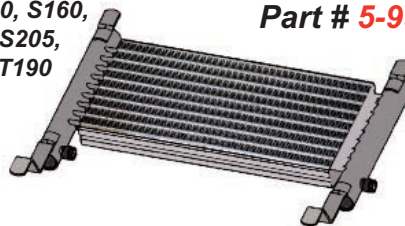

### SKIDSTEER

Models: S550, S570, S590, S750, S850, T590, T630, T650, T750, T770, T870

Part # **5-9955**

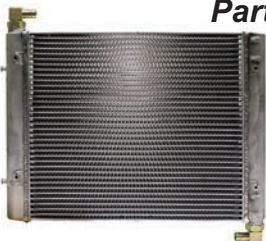

## Universal/Bobcat Heaters



•Works Great In Small Cabs - ATV/UTV & Skidsteer Applications

•12 Volt, Single Speed, Includes ON/OFF Toggle Switch

**Specifications:**  
Thickness/Depth- 5 1/2"  
Height- 6 1/8"  
Width- 8"  
Fitting Inlet- 5/8"  
Fitting Outlet- 5/8"  
Voltage- 12

**Part # AH1120**

and many more!

BOBCAT



# BOBCAT

## Radiators

**BOBCAT**

### SKIDSTEER

Models:

773T G Series,  
A300, S220,  
S250, S300,  
S330, T250,  
T300, T320



Part # **AR9300**

**AR9302**  
Models: 533, 543

**AR9303**  
Models: 542B

**AR9304**  
Models: 553, S130, T140

**AR9305**  
Models: 463, 553AF, S70

**AR9306**  
Models: 553F

**AR9307**  
Models: S150, S160, S175, S185, S205, T180, T190

**AR9308**  
Models: 773

**AR9309**  
Models: 733G, 773G, S150-S185, T190, T190G

**AR9310**  
Models: 825

**AR9311**  
Models: S150, S160, S175, S185, S205, T180, T190

**AR9312**  
Models: 843, 843B, 843H

### SKIDSTEER

Models: 843



Part # **AR9313**

**AR9314**  
Models: 853, 853C, 853H, 853HC

**AR9316**  
Models: 943

**AR9317**  
Models: 963C

**AR9319**  
Models: 963, 963G

**AR9325**  
Models: 453C, 453D, 453F, 463, 543, 543B, 553, 553C, 553F, 553G

**AR9327**  
Models: 743

**AR9330**  
Models: 642, 642B, 643, 742, 743

**AR9331**  
Models: S510-S650, T550, T590, T630, T650

**AR9333**  
Models: 751, 753, 753H, 753L, 763, 763C, 763H, 773, 7753

**AR9335**  
Models: S100, T110

**AR9350**  
Models: 430, 435

### EXCAVATOR

Models: 430, 435



Part # **AR9350**

### EXCAVATOR

Models: E42, E45,  
E50, E55

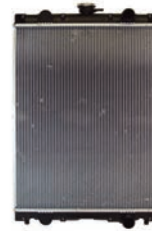

Part # **AR9351**

### TOOLCAT

Models:  
5600

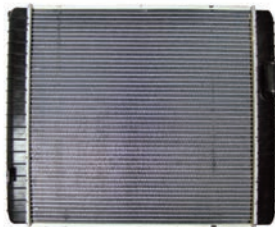

Part # **AR9328**



Part # **F5915**

## Heater Core & Evaporator Cleaner

- Powerful Foaming Action Penetrates Evaporator for Superior Cleaning.
- Cleans Evaporator Surface for Enhanced Air Flow and Better Cooling.

**1-800-806-5312**



# CASE

## Blower Motors

### WHEEL LOADER

Models: **Part # BM12413**  
 621, 621B,  
 621C, 721,  
 721B, 821,  
 821B, 821C,  
 921, 921B,  
 921C



### BACKHOE

Models: **Part # BM20007**  
 580M, 580M  
 Series 2,  
 580M Series  
 3



### BACKHOE/CRAWLER

Models: **Part # BM20010**  
 580D-580K,  
 590 Turbo,  
 680K, 680L,  
 780C, 780D



### WHEEL LOADER

Models: **Part # BM20047**  
 W11B

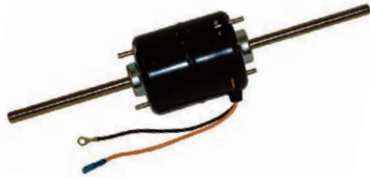

### WHEEL LOADER

Models: **Part # BM20057HD**  
 W11B



### WHEEL LOADER

Models: **Part # BM24215**  
 W14, W14C,  
 W14FL,  
 W18, W20,  
 W20B,  
 W24B



### WHEEL LOADER/CRAWLER

Models: **Part # BM24219**  
 1155E,  
 621B, 721B,  
 821B, 850D,  
 850E, 850G,  
 850H, 921



### WHEEL LOADER

Models: **Part # BM24223**  
 621, 621B



### EXCAVATOR

Models: **Part # BM24230**  
 688



### SKIDSTEER

Models: **Part # BM3903**  
 95XT



### SKIDSTEER

Models: **Part # BM4004**  
 60XT



### SKIDSTEER

Models: **Part # BM4005**  
 95XT

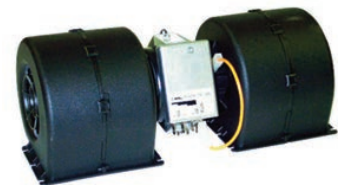

### WHEEL LOADER

Models: **Part # BM4008**  
 W11B



### CRAWLER

Models: **Part # BM4010**  
 650K, 750K,  
 850K



### SKIDSTEER

Models: **Part # BM40153**  
 420, 440CT,  
 445,  
 450

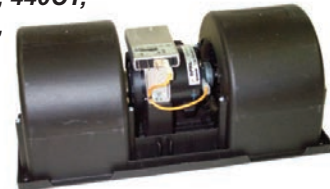

### CRAWLER

Models: **Part # BM40155-24**  
 1650,  
 1850K



### CRAWLER

Models: 1150D, **Part # BM4018**  
 1150E, 1150H,  
 1450B



### BACKHOE

Models: **Part # BM4019**  
 580 Super M,  
 580 Super N,  
 580 Super N WT,  
 580M/SM,  
 580M/SM Series 2,  
 580M/SM Series 3,  
 590 Super N,  
 590SM Series 2,  
 590SM Series 3



CASE



# CASE

## Blower Motors

CASE

### BACKHOE

Models:

580 Super M,  
580 Super N,  
580 Super N WT,  
580M/SM,  
580M/SM Series 2,  
580M/SM Series 3,  
590 Super N,  
590SM Series 2,  
590SM Series 3

Part # **BM40191**



### BACKHOE

Models:

580 Super M,  
580 Super N,  
580 Super N WT,  
580M/SM,  
580M/SM Series 2,  
580M/SM Series 3,  
590 Super N,  
590SM Series 2,  
590SM Series 3

Part # **BM40195**



### SKIDSTEER

Models:

75XT,  
85XT,  
90XT,  
95XT

Part # **BM4021**



### WHEEL LOADER/BACKHOE

Models:

570LX2-  
570MXT Se-  
ries 3, 580  
Super L-590,  
Super L

Part # **BM4020**



### WHEEL LOADER/BACKHOE

Models:

570LX2-  
570MXT Se-  
ries 3, 580  
Super L-590,  
Super L

Part # **BM40201K**

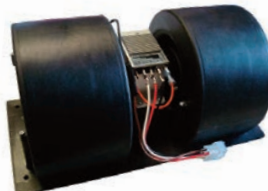

### WHEEL LOADER/BACKHOE

Models:

570LXT,  
570LXT Se-  
ries 2, 580L,  
580SL,  
509SL,  
590SL  
Series 2

Part # **BM4020K**



### WHEEL LOADER

Models:

521D, 621C,  
621D, 721D,  
821C, 921C

Part # **BM4020-24**



### WHEEL LOADER

Models:

521D, 621C,  
621D, 721D,  
821C, 921C

Part # **BM4020-24HD**



### SKIDSTEER

Models:

440, 450

Part # **BM4028**



### SKIDSTEER

Models:

420, 430,  
440, 440CT,  
450CT,  
445

Part # **BM40281**



### BACKHOE/CRAWLER

Models:

1150D, 1150E,  
1150G, 1150H,  
1450B, 580  
Super E,  
580D, 580G,  
680H, 680K,  
680L

Part # **BM4030**



### BACKHOE/CRAWLER

Models:

1150D, 1150E,  
1150G, 1150H,  
1450B, 580  
Super E,  
580D, 580G,  
680H, 680K,  
680L

Part # **BM4031**



### WHEEL LOADER/BACKHOE/CRAWLER

Models:

680H, 680K,  
780B, 780C

Part # **BM4032**



### WHEEL LOADER/BACKHOE/CRAWLER

Models:

680H, 680K,  
780B, 780C

Part # **BM40324**



### SKIDSTEER

Models:

221E

Part # **BM4045**



### WHEEL LOADER

Models:

1121F, 521E,  
621E, 621F,  
721E, 821E,  
921E, 921F

Part # **BM4047**



### WHEEL LOADER

Models:

921

Part # **BM4050**





## Blower Wheels

### WHEEL LOADER

Models: W14FL, W208



Part # **BW200**

**BW208**

Models: W11B, W20, W24B

**BW240**

Models: 621F

### EXCAVATOR

Models: 1150C-1150H, 1450B, 580 Super E, 580D, 680H, 780B, 850D-850H



Part # **BW285**

**BW290**

Models: 1150C-1150H, 1450B, 580 Super E, 580D, 680H, 780B, 850D-850H

**BW295**

Models: 1150D-1150H, 1155D, 1450B, 1550, 580 Super L, 580D-580SK, 621, 621B, 680H-680L, 721B, 780D, 850D-850H, 921, W14C, W30

## Compressors

### York to Sanden Conversion

Models: 580D, 580 Super E, 680K, 780D, W14-W36

Part # **990-90026**



### BACKHOE New York Rotolock

Models: 580 Super D & E, 580D, 580G, 680K, 780C, W14-W36

Part # **505-320**



### BACKHOE New York TCCI Rotolock

Models: 580 Super D & E, 580D, 580G, 680K, 780C, W14-W36

Part # **505-3201**



### SKIDSTEER OE Seltec TM-15 HD

Models: 430, 440CT, 445, 450

Part # **506-808**



### EXCAVATOR OE Sanden SD7B10

Models: CX75SR, CX80

Part # **509-371**



### SKIDSTEER OE Sanden SD5H11

Models: 420, 430, 435, 445, 450, 420CT, 440CT, 445CT, 450, 465

Part # **509-3974**



### SKIDSTEER OE Sanden SD5H11

Models: SR175, SV185

Part # **509-3978**



### SKIDSTEER Sanden SD5H11

Models: SR200, SR210, SV250, SV300, TR270, TR320, TV380

Part # **509-3979**



### SKIDSTEER OE Sanden SD5H11

Models: SR175, SV185

Part # **509-39796**



### EXCAVATOR OE Sanden SD7H13

Models: 9010B-9030B, CX130-CX330

Part # **509-399**



24V

### EXCAVATOR OE Sanden SD7H13

Models: CX135SR

Part # **509-3991**



24V

### EXCAVATOR OE Sanden SD7H13

Models: CX135SR, CX145CSR, CX160C, CX210B, CX225SR, CX250C, CX290, CX330, CX350C, CX460, CX800, CX80C

Part # **509-3992**



24V



# CASE

## Compressors

CASE

EXCAVATOR Sanden Style SD7H13  
Models: Part # 509-3993  
9010B-9030B,  
CX130-CX330



24V

CRAWLER OE Sanden SD5S14  
Models: Part # 509-4104  
1150D,  
1150E,  
1155D,  
1155E,  
1450B,  
1550,  
850D



24V

BACKHOE OE Sanden SD5S14  
Models: Part # 509-411  
580K



SKIDSTEER OE Sanden SD7H15  
Models: Part # 509-434  
430, 440,  
440CT,  
445, 450,  
450CT



W.L./EXC. OE Sanden SD5H14  
Models: Part # 509-436  
9010B-  
9040B,  
W14B,  
W14C



24V

BACKHOE OE Sanden SD7H15  
Models: Part # 509-560  
580L-580  
Super K,  
590L,  
680L,  
780D



BACKHOE OE Sanden SD7H15  
Models: Part # 509-567  
580SR,  
590SR,  
590SR Plus  
Series 2,  
590SR  
Series 2,  
695SR



CRAWLER OE Sanden SD7H15  
Models: Part # 509-5674  
1650,  
1650K,  
1850K



24V

MOTOR GRADER OE Sanden SD7H15  
Models: Part # 509-5704  
845, 865,  
885



24V

W.L. CRAWLER OE Sanden SD7H15HD  
Models: Part # 509-5771  
1150G, 1150K,  
155E, 1650L,  
521D, 621-  
621D, 721,  
721B, 821-  
821C, 850E,  
850G,  
921-921E



24V

WHEEL LOADER Sanden SD7H15  
Models: Part # 509-5784  
321E



24V

W.L. BACKHOE Sanden SD7H15  
Models: Part # 509-5981  
570MXT-  
590SM



WHEEL LOADER Sanden SD7H15  
Models: Part # 509-5984  
621E,  
721D,  
721E,  
821E,  
921F



24V

WHEEL LOADER OE Sanden SD7H15HD  
Models: Part # 509-6034  
1121F,  
521D,  
621D



24V

W.L./EXC. OE Sanden SD7H15  
Models: Part # 509-621  
521E,  
WX150,  
WX170,  
WX200



24V

MOTOR GRADER Sanden SD7H15  
Models: Part # 509-622  
845, 865,  
885



24V

W.L. BACKHOE OE Sanden SD7H15  
Models: Part # 509-63957  
321F,  
570NXT,  
580  
Super N,  
590  
Super N



W.L. BACKHOE Sanden SD7H15  
Models: Part # 509-6397  
580 Super N  
WT, 580SM  
Series 3,  
590SM  
Series 3





## Condensers

### BACKHOE Part # 400-2049

Models:  
580 Super M,  
580M Series 2,  
580SM Series 2,  
590SM Series 2,

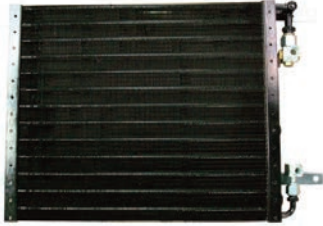

### BACKHOE 400-2050

Models: 580 Super M, 580M Series 2, 580SM Series 2,  
590SM Series 2

### BACKHOE 400-2051

Models: 580 Super M, 580M Series 2, 580SM Series 2,  
590SM Series 2

### WHEEL LOADER 400-2090

Models: 621, 621B, 621C, 721, 721B, 821, 821B, 821C,  
921, 921B, 921C

### WHEEL LOADER 400-2091

Models: 1121F, 521D, 621E, 621F, 721D, 721E,  
821E, 921F

### WHEEL LOADER/BACKHOE 400-2093

Models: 570MXT, 570NXT, 580 Super M, 580 Super N,  
580M, 580N, 580SM, 590 Super N, 590SM

### BACKHOE 400-2094

Models: 580 Super D - 580 Super L, 580D, 580K, 580L,  
580SR, 590 Super L, 590 Turbo, 590SR, 695SR

### EXCAVATOR 400-2098

Models: CX130, CX160, CX160C, CX210, CX210B, CX240,  
CX250C, CX290, CX350, CX350C

### WHEEL LOADER 400-3371

Models: 321F

### SKIDSTEER Part # 400-3380

Models:  
410, 420,  
420CT, 430,  
435, 440,  
440CT, 445,  
445CT, 450,  
465



## Evaporators

### WHEEL LOADER Part # 590-2215

Models:  
W14,  
W14FL,  
W18,  
W20,  
W20B,  
W24B, W36



### WHEEL LOADER 590-2208

Models: 621, 621B, 721, 721B, 821, 821B, 921, 921B



### BACKHOE 590-2228

Models: 580 Super K, 580 Turbo



### BACKHOE 590-2240

Models: 580 Super N, 580 Super N WT, 580M,  
580M Series 2 & 3, 580SM, 580SM Series 2 & 3,  
590 Super N, 590SM, 590SM Series 2 & 3

### SKIDSTEER 590-2238

Models: SR175, SR200, SR210, SV185, SV250, SV300,  
TR270, TR320, TV380

### WHEEL LOADER 590-2239

Models: 521E, 621E, 621F, 721E, 821E, 921E, 921F

### SKIDSTEER 590-2230

Models: 75XT

### BACKHOE 590-3075

Models: 580SR, 590SR, 590SR Plus Series 2,  
590SR Series 2, 695SR

### SKIDSTEER Part # 590-3080

Models:  
430, 435,  
440, 440CT,  
445, 445CT,  
450, 465





# CASE

## Expansion Valves

CASE

**WHEEL LOADER/BACKHOE**  
 Models: W14-W14FL, W18, W20-W20C, W24B, W30, W36, 621B, 821B  
**Part # 900-165**



**BACKHOE/CRAWLER**  
 Models: 1155E, 680H, 780B, 780C  
**Part # 900-170**



**EXCAVATOR**  
 Models: 9010B, 9020B, 9030B, 9040B, 9050B, 9060B  
**Part # 902-280**



**CRAWLER**  
 Models: 1650K, 1850K  
**Part # 903-700**



**SKIDSTEER/MOTOR GRADER**  
 Models: 420, 440, 440CT, 445, 450, 845, 865, 885, 885B  
**Part # 903-703**



**BACKHOE**  
 Models: 521D, 580L, 590L, 621C, 621D, 650H, 680L, 721D, 780D, 821D, 850G, 850H, 1150G, 1150H  
**Part # 903-705**



**WHEEL LOADER**  
 Models: 1121F, 621E, 621F, 721E, 821E, 921F  
**Part # 903-715**



**CRAWLER**  
 Models: 650K, 750K, 850K  
**Part # 903-7275**



**CRAWLER**  
 Models: 1650, 1850K  
**Part # 903-736**



**BACKHOE**  
 Models: 580SR, 695SR  
**Part # 903-744**



**SKIDSTEER**  
 Models: SR175, SR200, SR210, SV185, SV250, SV300, TR270, TV380  
**Part # 903-750**



**EXCAVATOR**  
 Models: CX130, CX160, CX210, CX240, CX290, CX330, CX460, CX800  
**Part # 903-830**



## Receiver Drier/Accumulators

**WHEEL LOADER**  
 Models: W14, W14F, W18, W20, W20B, W20C, W24B, W30  
**Part # 800-108**



**EXCAVATOR**  
 Models: 1150C-1150H, 1450B, 580 Super E, 580D, 680H, 780B, 850D-850H  
**Part # 802-200**



- New Heavy Duty Welded Construction.
- Made with Heavier Grade Steel.
- Double Reinforced Filter Pad & Screen System Prevents Desiccant Scatter.

**1-800-806-5312**



## Receiver Drier/Accumulators

### SKIDSTEER

Models: Part # **800-1116**

420, 435,  
440,  
440CT,  
445,  
445CT,  
450, 465,  
450CT,



### MOTOR GRADER

Models: Part # **800-1142**

845,  
865,  
885



### CRAWLER

Models: Part # **803-327**

1650,  
1850K



### CRAWLER

Models: Part # **803-328**

1650K,  
1850K,  
650K,  
750K,  
850K



### SKIDSTEER

Models: Part # **803-330**

465



### WHEEL LOADER

Models: Part # **803-371**

321F



### WHEEL LOADER

Models: Part # **803-395**

521E, 621E,  
721E, 821E,  
921E



### EXCAVATOR

Models: Part # **803-4462**

1288, 1488,  
588, 788,  
988,  
WX170,  
WX200

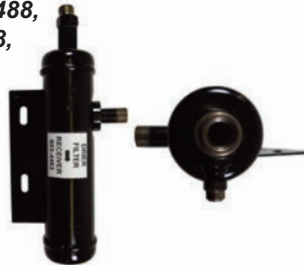

### EXCAVATOR

Models: Part # **803-450**

9010B-  
9060B,  
CX130-  
CX800



### WHEEL LOADER

Models: Part # **803-459**

924G-988G,  
938F-970F,  
950H-990H,  
953B,  
953C-973C



### CRAWLER

Models: Part # **804-506**

850D,  
1150D,  
1150E,  
1155D,  
1155E,  
1450B,  
1550



### CRAWLER

Models: Part # **804-535**

1155E



### BACKHOE

Models: Part # **804-545**

570LX2,  
570MXT, 580SK-  
580SL, 590,  
621B, 650H,  
780D, 821B,  
850E-850H,  
921B, 921C,  
1150G, 1150H



### WHEEL LOADER

Models: Part # **804-546**

570MXT,  
580M Series  
2 & 3



### WHEEL LOADER/SKIDSTEER

Models: Part # **804-550**

1121F, 521D,  
621D, 621F,  
721D, 912F,  
SR175-SR250,  
SV185,  
SV300,  
TR270,  
TR320,  
TV380





## Switches/Electrical

**3 Speed Blower Switch**  
Models: **Part # 205-102**  
850E, 850G

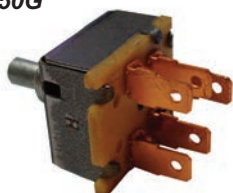

**3 Speed Blower Switch**  
Models: 420, 445, SR175, SV185, 580 Super D, E, & K, 590, 680H-680L, 780B-780D, 850D **Part # 205-103**

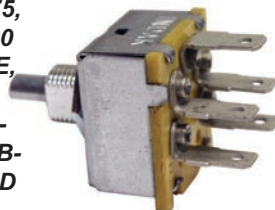

**3 Speed Blower Switch**  
Models: **Part # 205-125**  
721B, 721D, 821C, 921, 921C



**Thermostatic Switch**  
Models: 115E, **Part # 210-913**  
1550, 580 Super D & E, 580D, 580G, 680H, 680K, 780B, 780C, 850D

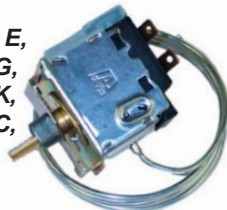

**Thermostatic Switch**  
Models: 570LX2-570NXT, 580 Super K & L, 580K-580SL, 590 Super L, 590 Turbo, 590SL **Part # 210-920**



**Thermostatic Switch**  
Models: **Part # 210-927**  
680L, 780D

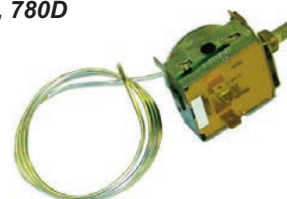

**Thermostatic Switch**  
Models: **Part # 210-952**  
420, 440, 440CT, 445

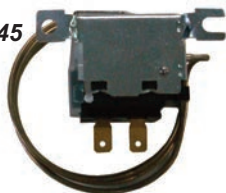

**Binary Pressure Switch**  
Models: **Part # 220-1022**  
420, 440, 440CT, 445, 445CT, 450, 465



**High Pressure Switch N/O**  
Models: **Part # 220-210**  
521D, 850H, 921C



**Low Pressure Switch N/C**  
Models: **Part # 220-3040**  
521D, 570LX2, 570MXT, 580L-650H, 850E-850L, 1150G

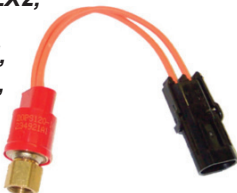

**High Pressure Switch N/O**  
Models: **Part # 220-3050**  
621B, 621C, 570LX2, 570MXT, 580L-580M, 590M, 650H, 850E-850L, 1150G



**High Pressure Switch N/O**  
Models: **Part # 220-3060**  
1155E, 580SK 580 Super K, 590 Turbo, 621, 621B, 680L, 721, 721B, 780D, 821, 821B,



**Low Pressure Switch N/C**  
Models: **Part # 220-3070**  
580SK, 921 580 Super K, 590 Turbo, 621, 621B, 680L, 721, 721B, 780D, 821, 821B,



**High Pressure Switch N/C**  
Models: **Part # 220-3075**  
580 Super D & E, 580D, 580G, 580K



**Low Pressure Switch N/O**  
Models: **Part # 220-3082**  
1150K, 1650L, 580M, 590SM, 850L, SR200



**High Pressure Switch N/C**  
Models: **Part # 220-3089**  
1150K, 1650L, 850L, 85XT, 90XT, 95XT, SR175-SR250, SV185, SV300, TR270, TR320, TV380



**Low Pressure Switch N/O**  
Models: **Part # 220-460**  
SR175, SR200, SV185, TV380



**Blower Speed Resistor**  
Models: **Part # 220-525**  
570LX2, 580 Super L, 580L, 590 Super L





## Switches/Electrical

### Blower Speed Resistor

Models:  
580K, 580SK  
680K,  
680L,  
780C,  
780D,  
580 Super E, K, & L,

Part # **220-529**

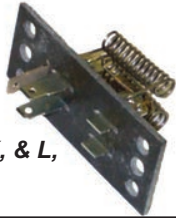

### Blower Speed Resistor

Models:  
580 Super M-  
580 Super N WT,  
580M-580SM,  
590 Super N,  
590SM, 75XT,  
85XT, 90XT,  
95XT

Part # **220-535**

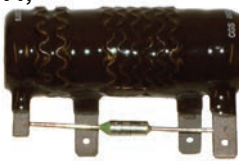

### Blower Speed Resistor

Models:  
75XT, 85XT,  
90XT, 95XT

Part # **220-536**



### Blower Speed Resistor

Models:  
521E,  
621E,  
721E,  
821E

Part # **220-566**



### Blower Speed Resistor

Models:  
570LX2,  
570LXT,  
570MXT,  
580L,  
580SL,  
590SL

Part # **220-609**



### Blower Speed Resistor

Models:  
PUMA 130,  
145, 160,  
170, 185,  
200, 215,  
230 CVT

Part # **220-626**



## Radiators

### WHEEL LOADER/BACKHOE

Models:  
570LXT,  
570MXT,  
580C-580M,  
584E-588G,  
590SL, 590SM,  
PX70, PX85

Part # **AR1564**



### BACKHOE/FORKLIFT

Models: 480E,  
480ELL, 480F,  
480FLL,  
580 Super D & E,  
584E, 585E, 586E

Part # **AR1556**

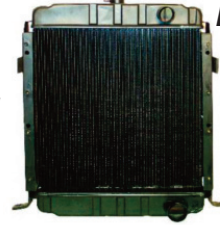

### WHEEL LOADER

**AR1117**

Models: 380CK

### BACKHOE

**AR1554**

Models: 480C

### SKIDSTEER

**AR1220**

Models: SR175, SR220, SR250, SV185, SV250, SV300,  
TR320, TV380

### WHEEL LOADER/BACKHOE

**AR1557**

Models: 530CK, 580B, 580CK

### POWER UNIT

**AR1246**

Models: PX70

### BACKHOE/TRENCHER

**AR1559**

Models: 580 Super K, 580K, 580SK, 660

### WHEEL LOADER

**AR1550**

Models: 380B

### SKIDSTEER/BACKHOE/FORKLIFT

**AR1560**

Models: 1845, 1845B, 1845S, 480D, 480LL, 580 Super D,  
580D, 580G, 584D, 585D, 586D

### WHEEL LOADER/BACKHOE

**AR1552**

Models: 430CK, 480B, 480CK, 530CK, 580B

### SKIDSTEER

**AR1561**

Models: 60XT, 70XT



# CASE

## Radiators

**BACKHOE**  
**AR1562**  
Models: 580C

**SKIDSTEER**  
**AR1573**  
Models: 1818, 1825

**SKIDSTEER**  
**AR1563**  
Models: 40XT

**SKIDSTEER**  
**AR1579**  
Models: SR220, SR250, SV250, SV300, TR320, TV380

**BACKHOE**  
**AR1565**  
Models: 590 Turbo

**SKIDSTEER**  
**AR1580**  
Models: SR175, SR200, SV185, TR270

**SKIDSTEER**  
**AR1566**  
Models: 75XT, 85XT, 90XT, 95XT

**SKIDSTEER**  
**AR2840**  
Models: 410, 420, 435, 440, 440CT, 445, 445CT, 450, 450CT, 465

**SKIDSTEER**  
**AR1567**  
Models: 1835, 1835B

**SKIDSTEER**  
**AR2841**  
Models: 410, 420, 420CT, 430, 435, 440, 440CT, 445, 445CT, 450, 450CT, 465

**SKIDSTEER**  
**AR1568**  
Models: 1840, 1845C

**EXCAVATOR**  
**AR6510**  
Models: CX27B

**SKIDSTEER**  
**AR1569**  
Models: 1838

**EXCAVATOR**  
**AR6512**  
Models: CX31B, CX36B

**SKIDSTEER**  
**AR1570**  
Models: 1835C

**EXCAVATOR**  
**AR6514**  
Models: CX31

**SKIDSTEER**  
**AR1572**  
Models: 1825, 1825B

**EXCAVATOR**  
**AR6523**  
Models: CX25, CX36

## Flushing Equipment



Part # 530-1060

1 Gallon Alcohol Base Flush,  
Fast Evaporating



Part # 530-1057  
A/C System Flush Gun Kit

**1-800-806-5312**

**CASE**



# CATERPILLAR

## Blower Motors

### WHEEL LOADER/DOZER

Models:  
939, D3C,  
D4C, D5C

Part # **BM11240**



### LOADER/DOZER/TRUCK/SCRAPER

Models:  
D6H, D7H,  
D10R, 14G,  
943, 953,  
777B-777D,  
916-926E,  
D25-D300D

Part # **BM11262**



### WHEEL LOADER/DOZER

Models:  
939, 953C,  
963C, 973C,  
D6R

Part # **BM11265**

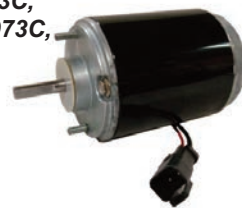

### WHEEL LOADER/DOZER

Models:  
D5M, D6M,  
D9R, 924F,  
953C, 963C,  
973C, IT24F,  
IT28F, IT38F

Part # **BM11266**



### WHEEL LOADER/DOZER

Models:  
814F, 815F,  
816F, 924F,  
939, 953C,  
963, 963C,  
973C, D5M,  
D6M, D6R,  
I24F-IT38F

Part # **BM11267**



### WHEEL LOADER

Models:  
980C

Part # **BM12410**



### WHEEL LOADER/DOZER

Models:  
910G, 914G,  
928G, 943,  
950F, 953,  
963B, 966F,  
973C, D6R,  
D6T, D8T,  
D9T

Part # **BM12416**

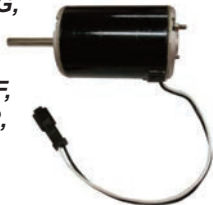

### EXCAVATOR/BUNCHER

Models: 1090,  
1190T, 1290T,  
312C, 315CL,  
318C, 319C,  
320D, 324D,  
325CL, 330CL,  
TK370, TK380,  
TK721-TK732

Part # **BM12420**



### LOADER/DOZER/GRADER

Models:  
12F, 631D,  
815, 920,  
951B, 966C,  
988B, D8K,  
225

Part # **BM24215**



### QUARRY TRUCK

Models:  
793B, 793C,  
797, 797B

Part # **BM24226**



### WHEEL LOADER

Models:  
906H, 906H2,  
907H, 907H2,  
908H,  
908H2,  
910K,  
914K

Part # **BM4049**



### COMPACTOR

Models:  
CP433E,  
CP44E, CP54B,  
CP56B, CS44,  
CP76, CS54,  
CP573E,  
CS56,  
CP583E,  
CP663E,

Part # **BM4063**



### BACKHOE/DOZER

Models:  
416D,  
420D,  
428D,  
430D,  
442D,  
446D,  
D5G

Part # **BM3502**



### WHEEL LOADER/DOZER

Models:  
950G-986H,  
D10T, D11T,  
D8T, D9T

Part # **BM3503**



### EXCAVATOR

Models:  
M313C,  
M315C,  
M316C,  
M318C,  
M322C,  
M325C

Part # **BM3510**



### EXCAVATOR

Models: 307D,  
311D-390DL,  
M313D-M325D,  
MH3022

Part # **BM3850**



### SKIDSTEER

Models:  
216B-299C

Part # **BM4005**

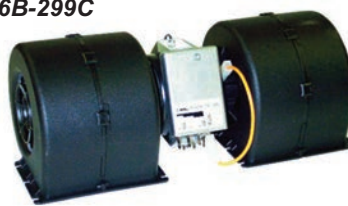

### WHEEL LOADER/SKIDSTEER

Models:  
216-277,  
901C,  
902C,  
903C,  
904B,  
904H

Part # **BM4007**



CATERPILLAR



# CATERPILLAR

## Blower Motors

CATERPILLAR

**WHEEL LOADER**  
 Models: **Part # BM40634**  
 950 GC



**WHEEL LOADER**  
 Models: **Part # BM40161**  
 902, 906, 908



**TELEHANDLER**  
 Models: **Part # BM40162**  
 TH220B-TH580B



**WHEEL LOADER**  
 Models: **Part # BM4051-24**  
 963D



**TRACK DOZER**  
 Models: **Part # BM4052**  
 D3K, D4K, D5K



**COMPACTOR/SCRAPER/PIPELAYER**  
 Models: **Part # BM4052-24**  
 CS64, CS76, D6N, D6R, D7R, 583, 587R



**STATIONARY ENGINE**  
 Models: **Part # BM4053-24**  
 3512, 3516



**TRACK DOZER**  
 Models: **Part # BM2697**  
 D5M



**WHEEL LOADER/DOZER**  
 Models: **Part # BM2698**  
 D4H, D8T, D9T, 914G, 928G, IT14G, IT28G



## Blower Wheels

**WHEEL LOADER**  
 Models: **Part # BW158**  
 T18F-IT38F



**EXCAVATOR**  
 Models: **Part # BW240**  
 307B-385B



**SKIDSTEER**  
 Models: **Part # BW282**  
 515-545C



## Condenser Fans

**WHEEL LOADER**  
 Models: **Part # FA101369-24**  
 914G-930H



24V

**EXCAVATOR**  
 Models: **Part # FA1214-24**  
 322CL



24V

**SKIDSTEER**  
 Models: **Part # FA914**  
 246C-299D XHP





# CATERPILLAR

## Compressors/Conversions Kit

### 24V A6/Delco to Sanden Conversion Kit



CAT 24V Applications

**A6/Delco**

**vs.**

**Sanden**



Part # 990-184

#### Benefits of Conversion Kit

- Direct Fit
- Steel Mounting Brackets
- Uses Original Hoses and Belts
- New Sanden 7 Piston vs. Old Cast Iron 6 Piston
- Requires Less HP
- Less Belt Vibration
- Additional Switch/Charge Ports

### 24V A6/Delco to 10PA20HD Denso Style Conversion Kit

Part # 500-026



CAT 24V Applications

**A6/Delco**

**vs.**

**10PA20HD**

Part # 500-084



#### Benefits of Conversion Kit

- New Heavy Duty A6/Delco Replacement with 24 Volt, 7" Clutch
- Uses Original Hoses and Belts
- Replaces 10 & 2 o'clock Coil Positions
- Includes HD Dust Protection
- Old 6 Piston vs. New Piston for Greater Efficiency
- Requires Less HP

WHEEL  
LOADER  
Models:  
980C-994D,  
IT18-IT28B

Heavy Duty A6 Delco

Part # 500-086



24V

EXCAVATOR OE Denso 10PA15C  
Models:  
311B-380BL

Part # 503-1224

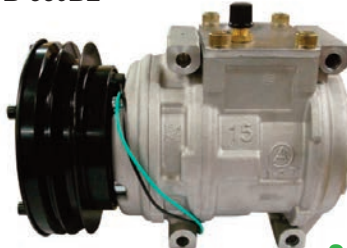

24V

EXCAVATOR OE Denso 10PA15C  
Models:  
350L, 375L

Part # 503-1226



24V

EXCAVATOR OE Denso 10S17C  
Models:  
307D,  
312C-345C

Part # 503-161

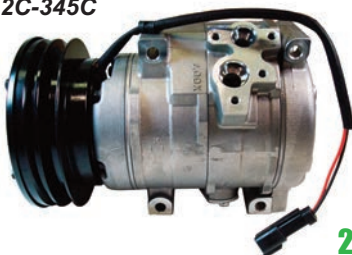

24V

EXCAVATOR OE Denso 10S17C  
Models:  
322CL-390DL

Part # 503-168



24V

YORK VALEO ROTOLOCK  
ARTICULATED  
TRUCK  
Models:  
D400

Part # 505-320





# CATERPILLAR

## Compressors

CATERPILLAR

EXCAVATOR  
Models:  
304CR-306,  
307B,  
308B

**Seltec TM-08B**  
Part # **506-748**

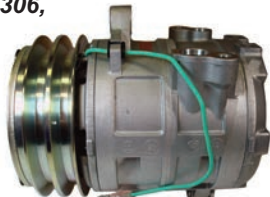

24V

SKIDSTEER  
Models:  
236B3-299C

**Seltec TM-08**  
Part # **506-752**



SKIDSTEER  
Models:  
216-277B

**Seltec TM-15HD**  
Part # **506-779**

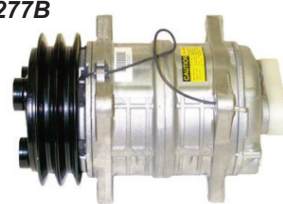

EXCAVATOR  
Models:  
303.5C-308C,  
314C,  
321C,  
321CR

**OE Zexel DKS15CH**  
Part # **506-845**



24V

BACKHOE.  
Models:  
414E-446D

**Seltec TM21HX**  
Part # **506-879**



EXCAVATOR  
Models:  
320

**Sanden SD505**  
Part # **509-390**



24V

EXCAVATOR  
Models:  
320

**Sanden SD5H09**  
Part # **509-396**



24V

EXCAVATOR  
Models:  
308D, 314C

**OE Sanden SD7H13**  
Part # **509-3991**



24V

EXCAVATOR  
Models:  
321C

**OE Sanden SD7H13**  
Part # **509-3994**



24V

WHEEL  
LOADER  
Models:  
906-914K

**OE Sanden SD7H13**  
Part # **509-3995**



MOTOR  
SCRAPER  
Models:  
613C-637E

**Sanden SD510**  
Part # **509-409**



24V

W.L.  
TRUCK  
Models:  
918F, 926E,  
936, 980F,  
D40D,  
D250D,  
D300D

**Sanden SD510**  
Part # **509-415**



**FLEX 7 Sanden SD7H15**  
Universal,  
Available in  
12 or  
24 Volts

Part # **509-5714**



24V

W.L./SCRAPER  
/DOZER  
Models:  
345BL,  
416-442D,  
627G,  
906-980E,  
D40D-  
D400D

**OE Sanden SD7H15**  
Part # **509-580**



BACKHOE.  
Models:  
416E-444F

**OE Sanden SD7H15E**  
Part # **509-581**

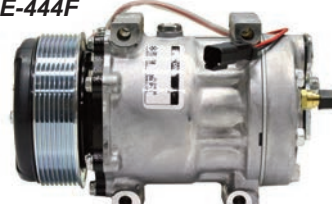

**FLEX 7 Sanden SD7H15**  
Universal,  
Available in  
12 or  
24 Volts

Part # **509-586**



24V

WHEEL  
LOADER  
Models:  
924G-973C,  
IT28F-  
IT62G

**OE Sanden SD7H15**  
Part # **509-588**

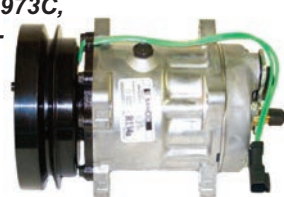

24V

EXCAVATOR  
Models:  
320D-374FL

**Sanden SD7H15**  
Part # **509-5976**

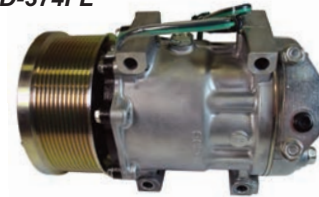

24V

1-800-806-5312



# CATERPILLAR

## Compressors

DOZER  
Models:  
D3K-D5K

**OE Sanden SD7H15**  
Part # **509-643**



PIPELAYER  
Models:  
583

**OE Sanden SD7H15**  
Part # **509-644**



QUARRY  
TRUCK  
Models:  
793F

**OE Sanden SD7S15**  
Part # **509-648**

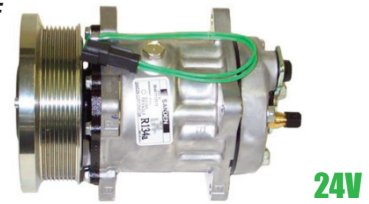

GRAPPLE  
SKIDDER  
Models:  
525C

**OE Sanden SD7H15**  
Part # **509-649**



MOTOR  
GRADER  
Models:  
140M3

**Sanden SD7H15HD**  
Part # **509-683**



W.L./DOZER  
Models:  
966K-972M,  
D11T,  
D6T-D9T

**OE Sanden SD7H15**  
Part # **509-697**



CATERPILLAR

## Condensers

**WHEEL LOADER/DOZER Part # 400-9004**

Models:  
D3C, D4C,  
D5C, D6R,  
D6T, D9R,  
836G, 953C,  
963C, 955C,  
996C



**WHEEL LOADER/DOZER Part # 400-9020**

Models:  
D3C, D4C,  
D5C, D6R,  
D6T, D9R,  
836G, 953C,  
963C, 955C,  
996C



**TELEHANDLER**  
**400-2050**

Models: TH220B-TH417C

**SKIDSTEER**  
**400-9200**

Models: 236B-287B

**TRACK SKIDDER**  
**400-9006**

Models: 515, 517, 527



**TRACK DOZER**  
**400-9007**

Models: D7R, D7R II, D8R, D8R II



**ARTICULATED/QUARRY TRUCK**  
**400-9008**

Models: 725-740, 769D-777D



**WHEEL LOADER**  
**400-9009**

Models: 950F II, 960F



**EXCAVATOR**  
**400-9010**

Models: 312C-330CL

**EXCAVATOR**  
**400-9011**

Models: 345B-375L



**WHEEL LOADER**  
**400-9012**

Models: 914G-930H, IT14G-IT28G



**EXCAVATOR**  
**400-9013**

Models: 311B-345BL

**EXCAVATOR**  
**400-9014**

Models: 324E-390F L

**MOTOR GRADER**  
**400-9016**

Models: 12H, 140H, 14H, 160H, 16H

**EXCAVATOR**  
**400-9017**

Models: 307D-308ES, 311D LRR-390DL, M313D-M324D2

**BACKHOE**  
**400-9018**

Models: 414E-444F



# CATERPILLAR

## Expansion Valves

<p><b>WHEEL LOADER/DOZER</b>  <b>Part # 900-165</b>            Models:            920, 950,            951B, 966C,            988B, 815,            D8K</p> 	<p><b>DOZER/TRUCK</b>  <b>Part # 902-210</b>            Models:            D10N, D11N,            D4H-D9N,            769C-789,            943-994D,            D25-D40D</p> 	<p><b>COMPACTOR</b>  <b>Part # 902-215</b>            Models:            836</p> 
<p><b>EXCAVATOR</b>  <b>Part # 902-218</b>            Models:            307C, 311C U,            320C, 320CL</p> 	<p><b>EXCAVATOR</b>  <b>Part # 902-282</b>            Models:            311B-330LN</p> 	<p><b>WHEEL LOADER/BACKHOE</b>  <b>Part # 903-700</b>            Models:            416B, 446B,            936F, 950F</p> 
<p><b>EXCAVATOR</b>  <b>Part # 903-737</b>            Models:            325C,            M312-M322C</p> 	<p><b>TELEHANDLER</b>  <b>Part # 903-739</b>            Models:            TH407C</p> 	<p><b>WHEEL LOADER</b>  <b>Part # 903-740</b>            Models:            916-980F,            IT18-IT28F</p> 
<p><b>EXCAVATOR</b>  <b>Part # 903-746</b>            Models:            307D,            320D-390DL</p> 	<p><b>EXCAVATOR</b>  <b>Part # 903-750</b>            Models:            312B-350L</p> 	<p><b>TRACK DOZER</b>  <b>Part # 903-7935</b>            Models:            D3K2 LGP-            D5K2 XL</p> 
<p><b>FELLER BUNCHER</b>  <b>Part # 903-801</b>            Models:            1090, 1190T,            1290T,            TK1051,            TK370,            TK380, TK711,            TK721,            TK722, TK732</p> 	<p><b>EXCAVATOR</b>  <b>Part # 903-852</b>            Models:            320E-374FL</p> 	<p><b>TELEHANDLER</b>  <b>Part # 903-856</b>            Models:            TH336C-            TH417C</p> 
<p><b>WHEEL LOADER</b>  <b>Part # 905-902</b>            Models:            906H-994K</p> 	<p><b>SKIDSTEER</b>  <b>Part # 905-915</b>            Models:            216B-299D            XHP</p> 	<p><b>BACKHOE</b>  <b>Part # 905-925</b>            Models:            414E-450F</p> 

CATERPILLAR



# CATERPILLAR

## Receiver Driers/Accumulators

### GRAPPLE SKIDDER

Models: **Part # 800-1282**  
525D, 535D,  
545D, 555D



Heavy Duty A/C Driers

### EXCAVATOR/LOADER/GRADER/DOZER

Models: **Part # 800-135**  
14H-163H, 312,  
318B-375L, 725-740, 769D-775D,  
950G-990H, D6N, D6R-D11R



Heavy Duty A/C Driers

### BACKHOE

Models: **Part # 800-1352**  
414E-450F



### WHEEL LOADER

Models: **Part # 800-137**  
930G, 930H,  
980H

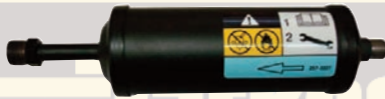

### TRUCK/DOZER

Models: **Part # 800-1376**  
730C, 735B, 740B, 770G-777G, 844K,  
854K, D11T, D6T, D8T, D9T



### WHEEL LOADER

Models: **Part # 800-1512**  
920, 950,  
951B, 966C



### MOTOR GRADER

Models: **Part # 802-200**  
140G



Heavy Duty A/C Driers

### EXCAVATOR

Models: **Part # 802-230**  
307C, 311C U,  
320C, 320CL



Heavy Duty A/C Driers

### TELEHANDLER

Models: **Part # 803-309**  
TH336C-  
TH417C



### WHEEL LOADER/BACKHOE

Models: **Part # 803-318**  
14G, 120G,  
140G, 416B,  
426B, 627G,  
919-953B



Heavy Duty A/C Driers

### DOZER/COMPACTOR/PIPELAYER

Models: **Part # 803-3239**  
824K-836K,  
D6T, D7E,  
PL72



Heavy Duty A/C Driers

### EXCAVATOR/BACKHOE

Models: **Part # 803-3275**  
303.5E2-308ES,  
415F2-444F2



Heavy Duty A/C Driers

### EXCAVATOR/DOZER

Models: **Part # 803-331**  
320-330,  
FD14E



Heavy Duty A/C Driers

### WHEEL LOADER

Models: **Part # 803-374**  
906, 908



### EXCAVATOR

Models: **Part # 803-450**  
311B-350L



### EXCAVATOR/LOADER/GRADER/DOZER/TRUCK

Models: **Part # 803-459**  
216B-242B, 257B,  
312, 318B, 345BL,  
375L, 416D-446D,  
525B, 725-740,  
769D, 771D,  
910G-990H,  
D5G-D10R,  
TH220B



### MOTOR GRADER

Models: **Part # 803-460**  
120H-16H



### SKIDSTEER

Models: **Part # 803-462**  
216-299D  
XHP



Heavy Duty A/C Driers

CATERPILLAR



# CATERPILLAR

## Receiver Driers/Accumulators

CATERPILLAR

### EXCAVATOR/LOADER/DOZER

Models: **Part # 804-500**  
225, 245,  
988B,  
D7G,  
D7G2,  
D8K



### WHEEL LOADER

Models: **Part # 804-525**  
988B



### TRACK DOZER

Models: **Part # 804-529**  
D3K2 LGP-  
D5K2 XL



### BACKHOE/DOZER

Models: **Part # 804-530**  
416-446B,  
814B-825C,  
D6H-D9N



### ARTICULATED/QUARRY TRUCK

Models: **Part # 804-531**  
D25, D30D-  
D40D,  
D350D,  
D400D



### TELEHANDLER

Models: **Part # 804-5354**  
TH210,  
TH215



### WHEEL LOADER/BACKHOE

Models: **Part # 804-536**  
416F-428F,  
906H-992K



### SKIDDER/SCRAPPER

Models: **Part # 804-5368**  
525D-555D,  
621H-627K



### ARTICULATED/QUARRY TRUCK

Models: **Part # 804-5369**  
730C-  
740B,  
773G-  
777G



### WHEEL LOADER/DOZER

Models: **Part # 805-4902**  
844K,  
854K,  
990K-  
994K



### BACKHOE

Models: **Part # 805-491**  
414E-450F



### WHEEL LOADER/DOZER

Models: **Part # 805-610**  
910G-980G,  
824G-844H,  
D4H-D11R,  
IT14G-IT38F



### EXCAVATOR/FORESTRY SWING MACHINE

Models: **Part # 805-6895**  
320E-390F,  
568



### EXCAVATOR

Models: **Part # 805-692**  
303.5C-307D,  
312C-390DL,  
M325C,  
M325D



### EXCAVATOR

Models: **Part # 805-6922**  
305, 305.5,  
306



### EXCAVATOR

Models: **Part # 805-694**  
308C-  
328D LCR



### Female Quick Disconnect

**Part # 451-439**





# CATERPILLAR

## Switches/Electrical

### Rocker Switch

Models: **Part # 206-725**  
914G, 928G,  
IT14G-  
IT38G



### Thermostatic Switch

Models: 12G, **Part # 210-910**  
225, 245,  
631D, 920,  
943, 953,  
955L, 988B,  
D250B,  
D5B-D9L



### Thermostatic Switch

Models: **Part # 210-936**  
416F-428F



### Thermostatic Switch

Models: **Part # 210-973**  
120H-24M,  
315-375L, 5230,  
525, 583,  
613-657E,  
725-797F,  
814-854K,  
906-992K



### Binary Pressure Switch N/O

Models: **Part # 220-1022**  
120G-16G,  
416-446B,  
FD14E



### Binary Pressure Switch N/O

Models: **Part # 220-1051**  
120H-16H,  
216-277,  
312-375L,  
416-446B,  
725-797F,  
901C-994D,  
D4C-D9T

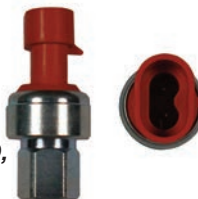

### Binary Pressure Switch N/O

Models: **Part # 220-1052HD**  
120H-16H,  
216-375L,  
416-446B,  
725-797F,  
901C-994D,  
IT14G-IT62G



### Binary High Pressure Switch

Models: **Part # 220-419**  
308D,  
312E-390F L,  
M318F



### Binary High Pressure Switch

Models: **Part # 220-424**  
307D,  
311F-390DL,  
M315D-  
M324D2



### Low Pressure Switch N/O

Models: **Part # 220-455**  
12M, 140M,  
256C-299D,  
924K-994K,  
CP433E-  
CS56B,  
D6K-D11T



### Temperature Sensor

Models: **Part # 220-475**  
345BL



### Blower Speed Resistor

Models: **Part # 220-531**  
414E-450F,  
938H, IT38H,

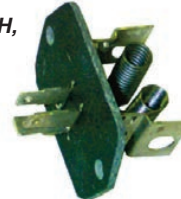

### Blower Speed Resistor

Models: **Part # 220-544**  
24M, 312B-  
345BL, 621G-  
637G,  
773D-  
797F,  
D11R,  
IT62G, IT62H



### Blower Speed Resistor

Models: **Part # 220-5443**  
120H-16H,  
315-375L,  
613C-  
637G,  
785-  
793C,  
910G-988H



### Trinary Switch N/O

Models: **Part # 220-5660**  
TH210,  
TH215



### Trinary Switch N/O

Models: **Part # 220-5642**  
MT425,  
MT445,  
MT455,  
MT465



### Blower Speed Resistor

Models: **Part # 220-620**  
MT525B-  
MT665B



### 12V 4 Pole Helta Relay

Models: **Part # 550-232**  
TH210, TH215



CATERPILLAR



# CATERPILLAR

## Oil Coolers

### WHEEL LOADER

Models:  
938H,  
IT38H

Part # **5-9080**

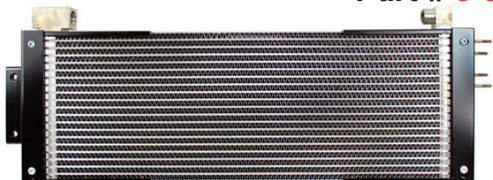

### GRADER/EXCAVATOR/LOADER/DOZER

Models:  
120H-160K,  
320B-329DL,  
928G-966F,  
D5M-D6N,  
IT28F-IT62H,  
M325B, M325D

Part # **5-9090**



## Radiators

### LOADER/MOTOR GRADER/DOZER/TRUCK

Models:  
16G, 621G-637E,  
793C, 815B,  
816B, 966E,  
D6D, D6H, D7G,  
D7H, D8N

Part # **RC92005**



### PIPELAYER/DOZER

**RC92089**

Models: 583R, D7R, D8R

### TRACK DOZER

**RC92097**

Models: D9N

### EXCAVATOR

**IR02011**

Models: 311B, 312B

### WHEEL LOADER

**RC92109**

Models: 988G

### EXCAVATOR

**IR02012**

Models: 320B

### WHEEL LOADER

**RC92135**

Models: 916-936E, IT18-IT28B

### EXCAVATOR

**IR02014**

Models: 320C, 320CL

### TRACK DOZER

**RC92145**

Models: D6D

### EXCAVATOR

**IR02015**

Models: 312C

### MOTOR SCRAPER

**RC92155**

Models: 627E-637G

### STATIONARY ENGINE

**RC92015**

Models: 3412-3612

### WHEEL LOADER/DOZER

**RC92167**

Models: 936F, D4H, IT18B

### QUARRY TRUCK

**RC92025**

Models: 776D-797B

### WHEEL LOADER

**RC92177**

Models: 950F, 960F

### STATIONARY ENGINE/TRUCK

**RC92035**

Models: 3508-3516, 784C-789B

### TRACK DOZER

**RC92187**

Models: D6D, D6H, D7H

### TRACK DOZER

**RC92045**

Models: D11N

### WHEEL LOADER/DOZER

**RC92197**

Models: 814F-816F, 966F-980F

### MOTOR GRADER/DOZER

**RC92069**

Models: 24H, D10R, D9R

### WHEEL LOADER/DOZER

**RC92209**

Models: 980G, D8R

### MOTOR SCRAPER

**RC92079**

Models: 621G-627G

### TRACK DOZER

**RC92219**

Models: D9R



# FORD/NEW HOLLAND

## Blower Motors

FORD/NEW HOLLAND

**SKIDSTEER**  
Models: L785  
Part # **BM11203**



**SKIDSTEER**  
Models: L553, L785  
Part # **BM11208**



**BACKHOE**  
Models: 555, 555A, 555B, 655, 655A, 755A, 755B  
Part # **BM11238**



**SKIDSTEER**  
Models: LX465-LX985  
Part # **BM20008**



**BACKHOE**  
Models: 550-755B  
Part # **BM20050**

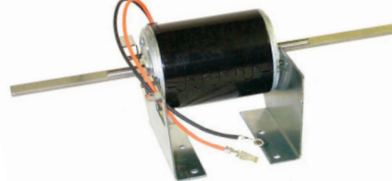

**EXCAVATOR**  
Models: EH130, EH215  
Part # **BM3675**



**BACKHOE**  
Models: 555, 555A, 555B  
Part # **BM20057HD**



**BACKHOE**  
Models: 555, 555A, 555B  
Part # **BM20057HDK**



**EXCAVATOR**  
Models: E215B  
Part # **BM3835**



**BACKHOE**  
Models: 445D, 545D  
Part # **BM3891**



**TELEHANDLER**  
Models: LM410, LM415, LM420, LM425A, LM430, LM435, LM445  
Part # **BM4005**



**BACKHOE**  
Models: 455C-675D  
Part # **BM4011**



**SKIDSTEER**  
Models: LX465-LX985  
Part # **BM40112**



**BACKHOE**  
Models: 555E-675E, B95, B95B, LB90-LB110  
Part # **BM4015**



**SKIDSTEER**  
Models: C175-C190, L170-L190, LS140-LS190B, LT185B, LX465-LX985  
Part # **BM40153**



**CRAWLER DOZER**  
Models: DC180B  
Part # **BM40155-24**

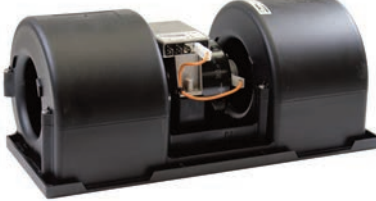

**BACKHOE**  
Models: 550-755B  
Part # **BM4080**

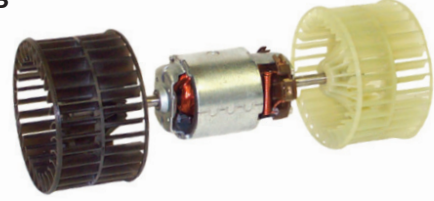



# FORD/NEW HOLLAND

FORD/NEW HOLLAND

## Blower Wheels

**SKIDSTEER**  
Models: LX465-LX985  
Part # **BW098**



**SKIDSTEER**  
Models: LX465-LX985  
Part # **BW099**



**BACKHOE**  
Models: 555D-675D  
Part # **BW200**



**BACKHOE**  
Models: 550-755B  
Part # **BW212**



**BACKHOE**  
Models: 550-755B  
Part # **BW216**



**SKIDSTEER**  
Models: L218  
**Engine Fan**  
Part # **EF1249**



## Condenser Fans

**TELEHANDLER**  
Models: LM5060, LM5080  
Part # **FA1014**



**WHEEL LOADER**  
Models: LW110, LW130  
Part # **FA111369-24**



**CRAWLER DOZER**  
Models: DC180B  
Part # **FA7513-24**



## Condensers

**WHEEL LOADER**  
Models: LW170.B  
Part # **400-2091**



**BACKHOE**  
Models: B95, LB75.B, LB90.B  
Part # **400-2094**



**BACKHOE**  
Models: 555E-675E, LB90-LB110  
Part # **400-3345**



**SKIDSTEER**  
Models: C185, C190, L180-L190, LS180B-LS190B, LT185B, LT190B  
Part # **400-3372**



**SKIDSTEER**  
Models: C175, C190, L175, L190  
Part # **400-3390**



Part # **F5915**



## Condenser Coil Cleaner

Powerful Foaming Action Pulls Out Debris!

1-800-806-5312



# FORD/NEW HOLLAND

## Compressors/Conversion Kits

### York to Sanden Conversion Kit

Part # **505-322**



**York**

Part # **990-90026R**



vs. **Sanden**

**Increased  
Compressor Life**

#### **Benefits of Conversion Kit**

- Improves Cooling Performance
- Eliminates Front Seal Failure
- Direct Fit
- Uses Original Hoses & Belts
- Rugged Cast Iron Mount
- Less Belt Vibration
- New 7 Piston vs. Old 2 Piston
- Requires Less HP
- Sanden is #1 Choice of O.E. Manufacturers

BACKHOE **York TCCI Rotolock**  
Models: **Part # 505-3221**  
550-755B



SKIDSTEER **Seltec TM-15**  
Models: **Part # 506-808**  
C185



**FLEX 7 Sanden SD7H15**  
Universal, **Part # 509-5714**  
Available in  
12 or  
24 Volts



**24V**

BACKHOE **OE Sanden SD7B10**  
Models: **Part # 509-372**  
555E, 675E



SKIDSTEER **Sanden SD5H11**  
Models: **Part # 509-397**  
C175, L175

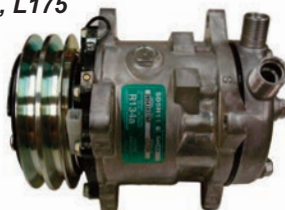

SKIDSTEER **OE Sanden SD5H11**  
Models: **Part # 509-3974**  
C185, C190,  
L180-L190



SKIDSTEER **OE Sanden SD5H11**  
Models: **Part # 509-3978**  
L218,  
L220



SKIDSTEER **Sanden SD5H11**  
Models: **Part # 509-3979**  
C227,  
L223-  
L230



SKIDSTEER **OE Sanden SD5H11**  
Models: **Part # 509-39796**  
L218, L220



EXCAVATOR **OE Sanden SD7H13**  
Models: **Part # 509-3991**  
E215B, EH130



**24V**

BACKHOE **OE Sanden SD7H15**  
Models: **Part # 509-414**  
555C-675D



SKIDSTEER **OE Sanden SD7H15**  
EXCAVATOR  
Models: **Part # 509-434**  
C185, C190,  
EC215,  
EC270,  
L185-  
LT190B



**FORD/NEW HOLLAND**



# FORD/NEW HOLLAND

## Compressors/Components

FORD/NEW HOLLAND

**BACKHOE Sanden SD7H15SHD**  
Models: **Part # 509-5532**  
555C-675D



**DOZER OE Sanden SD7H15**  
Models: **Part # 509-560**  
DC95



**TELEHANDLER OE Sanden SD7H15**  
Models: **Part # 509-566**  
LM410-  
LM640



**BACKHOE OE Sanden SD7H15**  
Models: **Part # 509-567**  
B95-LB90.B



**WHEEL LOADER OE Sanden SD7H15**  
Models: **Part # 509-5674**  
LW110-  
LW270



**BACKHOE OE Sanden SD7H15**  
Models: **Part # 509-576**  
B95B

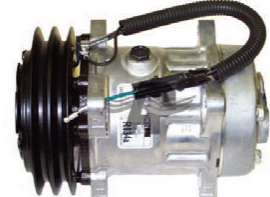

24V

**WHEEL LOADER OE Sanden SD7H15HD**  
Models: **Part # 509-5771**  
W130



24V

**TELEHANDLER Sanden SD7H15**  
Models: **Part # 509-5981**  
LM415A-  
LM445A



**WHEEL LOADER Sanden SD7H13**  
Models: **Part # 509-5984**  
LW170.B



24V

**BACKHOE Sanden SD7H15**  
Models: **Part # 509-610**  
555E-675E,  
LB90-  
LB115



**TELEHANDLER Sanden SD7H15**  
Models: **Part # 509-612**  
LM5040-  
LM5080



**MOTOR GRADER Sanden SD7H15**  
Models: **Part # 509-622**  
RG140



24V

**Tecumseh HG1000 Large Bearing Shaft Seal Kit**  
**Part # 440-214**



**6 Bolt Front Plate Seal Kit York**  
**Part # 440-216**



**Sanden SD507, 508, 510 Carbon Shaft Seal Kit**  
**Part # 440-346**



**Sanden Clutch Bearing**  
Models: **Part # 440-718**  
SD7H15,  
SD708, SD709,  
SD7B10,  
SD505,  
SD5H09,  
SD5H11,  
SD5H13,



**Sanden Clutch Bearing**  
Models: **Part # 440-762**  
SD507, 508,  
510, 5H14



**Lip Type Shaft Seal Kit**  
Models: **Part # 440-993**  
SD507, 508,  
510, SD709CA,  
SD709CP,  
SD7B10, SD7,  
SD5H13,  
SD5H14,  
SD7H15, SP10



**1-800-806-5312**



# FORD/NEW HOLLAND

## Expansion Valves

FORD/NEW HOLLAND

**WHEEL LOADER**  
 Models: **Part # 900-170**  
 A64



**BACKHOE**  
 Models: **Part # 902-210**  
 555-755B



**BACKHOE**  
 Models: **Part # 902-215**  
 555-755B



**BACKHOE**  
 Models: **Part # 903-700**  
 555C-675D,  
 DC150,  
 LM430,  
 LM435A



**SKIDSTEER**  
 Models: **Part # 903-703**  
 C175-C190,  
 L175-L190,  
 LS180B,  
 LS185B,  
 LT185B,  
 LT190B



**BACKHOE**  
 Models: **Part # 903-725**  
 555E-675E,  
 LB115,  
 LB75



**WHEEL LOADER**  
 Models: **Part # 903-7275**  
 LW110-  
 LW190.B



**TELEHANDLER**  
 Models: **Part # 903-736**  
 LM5060,  
 LM5080



**EXCAVATOR**  
 Models: **Part # 903-739**  
 EC215,  
 EC270



**BACKHOE**  
 Models: **Part # 903-744**  
 B95, B95B,  
 LB75.B,  
 LB90.B



**SKIDSTEER**  
 Models: **Part # 903-750**  
 L218-L230



**EXCAVATOR**  
 Models: **Part # 903-830**  
 EH130



## Evaporators

**SKIDSTEER**  
 Models: **Part # 590-3070**  
 C175-C190,  
 L175-L190,  
 LS180B,  
 LS185B, LT185B,  
 LT190B



**BACKHOE**  
 Models: **Part # 590-3075**  
 LB75-LB110



**SKIDSTEER**  
 Models: **Part # 590-8502**  
 L170





# FORD/NEW HOLLAND

## Receiver Driers/Accumulators

FORD/NEW HOLLAND

**SKIDSTEER**  
**Part # 800-1116**  
 Models: C175-C190, L175-L190, LS180-LS190, LT185B, LT190B



**MOTOR GRADER**  
**Part # 800-1142**  
 Models: RG140



**TELEHANDLER**  
**Part # 800-124**  
 Models: LM410-LM5080



**BACKHOE**  
**Part # 800-179**  
 Models: 555E-675E, LB75-LB115



**EXCAVATOR**  
**Part # 803-309**  
 Models: EC215, EC270



**BACKHOE**  
**Part # 803-318**  
 Models: 555E-675E, LB75-LB115



**BACKHOE**  
**Part # 803-327**  
 Models: B95, B95B, LB75.B



**CRAWLER DOZER**  
**Part # 803-328**  
 Models: DC150, DC95



**LOADER/BACKHOE**  
**Part # 803-395**  
 Models: 555E-675E, LW110-LW270



**EXCAVATOR**  
**Part # 803-450**  
 Models: E215B, EH130



**BACKHOE**  
**Part # 804-548**  
 Models: LB75.B, LB90.B



**SKIDSTEER/BACKHOE**  
**Part # 804-550**  
 Models: 555C-675D, L218-L230



## A/C Tools & Equipment

**Mastercool 6CFM Vacuum Pump**



**Mastercool Digital Gauge Set**



**Part # 530-90070**

Includes: 6CFM Vacuum Pump, Digital Gauge Set & Digital Scale

**Accu-Charge II Digital Refrigerant Scale**



**1-800-806-5312**



# FORD/NEW HOLLAND

## Switches/Electrical

**3 Speed Blower Switch**  
Models: Part # **205-103**

550-755B,  
C175-C190,  
L185, L220,  
LS185B



**3 Speed Blower Switch**  
Models: Part # **205-104**

LS180,  
LX465-  
LX985



**3 Speed Blower Switch**  
Models: Part # **205-132**

555E-  
675E,  
LB75-  
LB115

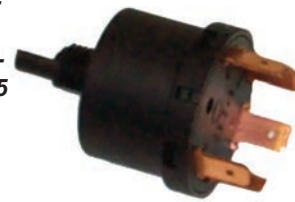

**Thermostatic Switch**  
Models: Part # **210-9012**

555C-675D



**Thermostatic Switch**  
Models: Part # **210-930**

550



**Thermostatic Switch**  
Models: Part # **210-952**

C190,  
L175-L190,  
LS180,  
LS185B,  
LT185B,  
LT190B

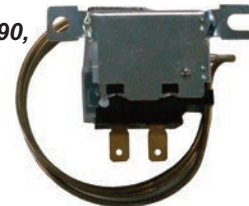

**Binary Pressure Switch N/O**  
Models: Part # **220-1022**

C175-C190,  
L175-L190,  
LM430,  
LS180,  
LT185B,  
LT190B



**Low Pressure Switch N/O**  
Models: Part # **220-3082**

L223, L230



**High Pressure Switch N/C**  
Models: Part # **220-3089**

L218-L230



**Low Pressure Switch N/O**  
Models: Part # **220-460**

L218, L220



**Blower Speed Resistor**  
Models: Part # **220-525**

555D-755B



**Blower Speed Resistor**  
Models: Part # **220-526**

550-755B



**Thermo-Disc Switch**  
Models: Part # **220-533**

550



**Blower Speed Resistor**  
Models: Part # **220-810**

555E-  
675E,  
B95,  
LB75-  
LB115



Pag 46 8oz. Part # **520-3012**  
Pag 100 8oz. Part # **520-3013**  
Pag 150 8oz. Part # **520-3014**



### Ultra Double End Capped R134a Pag Oil

The unique, patented, double "end capped" formula of PAG provides exceptional chemical stability to the oil in any A/C system. Double End Capped PAG is the #1 choice of many O.E. Manufacturers when retrofitting R12 to R134a



# FORD/NEW HOLLAND

## Radiators

### LOADER/BACKHOE/UTILITY

Models:  
340, 340A,  
340B, 420,  
445A, 450, 532,  
535-545A,  
3500-4500

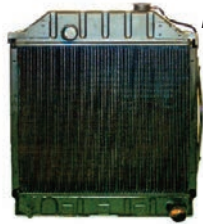

Part # **AR2109**

### SKIDSTEER

Models:  
L140-L170,  
LS140-LS170

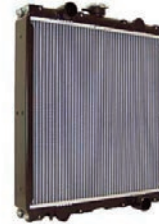

Part # **AR2839**

**SKIDSTEER**  
**AR1220**

Models: C232, C238, L218, L230

**BACKHOE**  
**AR2819**

Models: 555A, 655A

**SKIDSTEER**  
**AR1579**

Models: C232, C238, L218, L230

**BACKHOE**  
**AR2821**

Models: 555-655A

**SKIDSTEER**  
**AR1580**

Models: C232, C238, L218, L230

**BACKHOE**  
**AR2830**

Models: 445D-675D

**BACKHOE**  
**AR2102**

Models: 750-755B

**BACKHOE**  
**AR2832**

Models: 555E-675E, LB75

**STATIONARY ENGINE**  
**AR2103**  
Models: 1.3

**SKIDSTEER**  
**AR2837**

Models: C185, C190, L180-L190

**LOADER/UTILITY/BACKHOE**  
**AR2115**

Models: 340-545A, 3500-4500

**SKIDSTEER**  
**AR2840**

Models: C175-C190, L175-L190, LS180B-LS190B

**LOADER/UTILITY/BACKHOE**  
**AR2117**

Models: 340-545A, 3500-4500

**SKIDSTEER**  
**AR2841**

Models: C175-C190, L175-L190, LS180B-LS190B

**LOADER/UTILITY/BACKHOE**  
**AR2120**

Models: 340-545A, 3500-4500

**LOADER/UTILITY/BACKHOE**  
**AR2842**

Models: 340A, 340B, 540A, 540B

**BACKHOE**  
**AR2125**  
Models: 6500

**SKIDSTEER**  
**AR2844**

Models: L783, L785

**UTILITY**  
**AR2149**  
Models: 250C, 260C

**SKIDSTEER**  
**AR2846**

Models: L255, LS125

**WHEEL LOADER/BACKHOE**  
**AR2801**  
Models: 445A-545A, 445D-545D

**SKIDSTEER**  
**AR2847**

Models: L454, L455

**BACKHOE**  
**AR2805**

Models: 445D-655D

**SKIDSTEER**  
**AR2848**

Models: L465-L665, LS140-LS170, LX465-LX665

**BACKHOE**  
**AR2810**

Models: 555, 555A, 555B

**SKIDSTEER**  
**AR2850**

Models: L865, L885, LS180, LX865, LX885

**BACKHOE**  
**AR2818**

Models: 550-655A

**SKIDSTEER**  
**AR2854**

Models: L779-L785

FORD/NEW HOLLAND



# HITACHI

## Compressors

Models:  
EX330LC

**OE Denso 10PA15C**

Part # **503-122**



24V

Models:  
160LC,  
EX1200-6

**OE Denso 10S15C**

Part # **503-124**

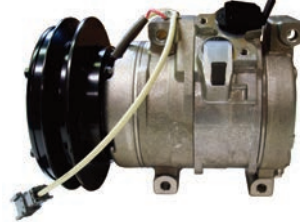

24V

Models:  
200LC-3,  
EX200LC,  
EX200LC-5,  
ZX330LC

**OE Zexel DKS15CH**

Part # **506-850**



24V

Models:  
350LC,  
EX330LC,  
ZX200,  
ZX350LC-3

**OE Zexel DKS15CH**

Part # **506-853**



24V

Models:  
EX100-5-  
EX210H-5,  
EX210LCH-5

**OE Zexel DKS15CH**

Part # **506-857**



24V

## Condensers

Models: 120-3 - 330-3, 350LC, 330EX,  
210H-3, 350H-3, 210K-3 - 350K-3, 240N-3,  
190W-3, 220-3, 75US3, 160LC-3 - 350LC-3,  
135US-3, 225US-3, 350K-EX, 85USB-3,  
135USK-3, 330LC-DH, 330LC-DM,  
330LC-EX, 350K-3HG, 135 USK-3,  
210LCH-3 - 350LCH-3, 210LCK-3,  
350LCK-3, 210LCN-3 - 350LCN-3, 330-3-EX

**EXCAVATOR**



Part # **400-5596**

## Receiver Driers/Accumulators

Models:  
EX100-5-  
EX200-5,  
EX210H-5,  
EX210LCH-5

**EXCAVATOR**

Part # **803-450**



Models:  
350LC,  
ZX350LC-3

**EXCAVATOR**

Part # **805-693**



Models:  
EX1200-6,  
ZX330LC

**EXCAVATOR**

Part # **805-694**



Models:  
EX330LC

**EXCAVATOR**

Part # **805-700**



**AP Air Inc.**  
Heavy Duty A/C Driers



# HITACHI

## Expansion Valves

### EXCAVATOR

Models:  
ZX350LC-3

Part # **903-715**



### EXCAVATOR

Models:  
ZX330LC

Part # **903-758**



### EXCAVATOR

Models:  
ZX350LC-3

Part # **903-761**



## Radiators

### EXCAVATOR

Models:  
225USR-3,  
ZX200

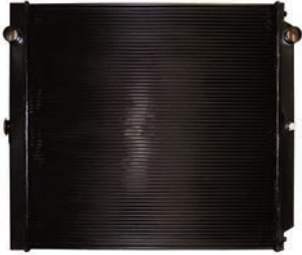

Part # **IR24045**

### EXCAVATOR

**IR24046**

Models: ZX110, ZX120, ZX135

### EXCAVATOR

**IR24047**

Models: ZX200

## Single & Double Row Light Bars

6" Single Row LED, 3400 Lumens

Part # **3-106**



50" Double Row LED, 21,100 Lumens

Part # **3-250**



10" Single Row LED, 5700 Lumens

Part # **3-110**



42" Double Row LED, 14,500 Lumens

Part # **3-242**



20" Single Row LED, 11,300 Lumens

Part # **3-120**



32" Double Row LED, 9900 Lumens

Part # **3-232**



30" Single Row LED, 13,600 Lumens

Part # **3-130**



22" Double Row LED, 7200 Lumens

Part # **3-222**



40" Single Row LED, 17,300 Lumens

Part # **3-140**



14" Double Row LED, 5400 Lumens

Part # **3-214**



50" Single Row LED, 25,200 Lumens

Part # **3-150**



8" Double Row LED, 2650 Lumens

Part # **3-208**



**1-800-806-5312**

HITACHI



## Blower Motors

**LOADALL**  
Part # **BM11249**  
Models: 520-540

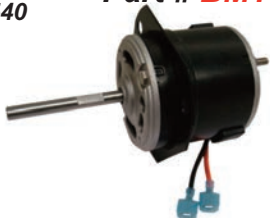

**TELESCOPIC HANDLER**  
Part # **BM112492**  
Models: 525-58-537-130



**LOADALL**  
Part # **BM3650**  
Models: 520-550

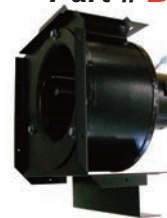

**LOADALL**  
Part # **BM3882**  
Models: 531-70-541-70



**LOADALL**  
Part # **BM3903**  
Models: 520



**FORKLIFT**  
Part # **BM3904**  
Models: 940-4



**LOADALL/HANDLER**  
Part # **BM4014**  
Models: 530-550, 530-550-140



**WHEEL LOADER**  
Part # **BM40155-24**  
Models: 411-456



**EXCAVATOR**  
Part # **BM4024**  
Models: JS115-JS360



**WHEEL LOADER**  
Part # **BM4126-24**  
Models: 411-437



**LOADALL**  
Part # **FA1024**  
Models: 524



**TRACTOR**  
Part # **BM4123**  
Models: 8250



## Condensers

**LOADER/EXCAVATOR** Part # **400-5420**  
Models: 426-456B, JS145-JS330, 714-722

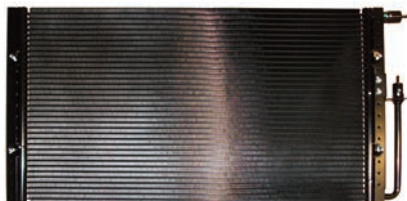

**LOADALL**  
Part # **400-5435**  
Models: 520-528S

**LOADER/HANDLER/LOADALL/EXCAVATOR**  
Part # **400-5442**  
Models: 406, 409, 531-560, 8025-8035, TM180-TM220

**LOADALL**  
Part # **400-5425**  
Models: 520-550

**WHEEL LOADER**  
Part # **400-5445**  
Models: TM310, TM-W

**BACKHOE/HANDLER/LOADALL**  
Part # **400-5430**  
Models: 210-217, 530-550, 718, 8080

**BACKHOE/LOADER/LOADALL/HANDLER**  
Part # **400-5450**  
Models: 210-217, 2CX-4CX, 411-456, 520-540, 8080



## Compressors

SKIDSTEER  
Models:  
T190

**Sanden SD505**  
Part # **509-394**



WHEEL  
LOADER  
Models:  
420-437

**OE Sanden SD5S14**  
Part # **509-4104**



24V

LOADALL  
Models:  
520-540

**OE Sanden SD7H15**  
Part # **509-434**



EXCAVATOR  
Models:  
JS130-  
JS330

**OE Sanden SD7H15**  
Part # **509-4348**



24V

W.L./  
BACKHOE.  
Models:  
220-217,  
406-427,  
TM180,  
TM220

**OE Sanden SD7H15**  
Part # **509-435**



W.L./TRUCK  
Models:  
426B, 718

**OE Sanden SD7H15**  
Part # **509-4354**



24V

EXCAVATOR  
Models:  
LS130

**OE Sanden SD5H14**  
Part # **509-436**



DUMP TRUCK  
Models:  
722

**Sanden SD7H15**  
Part # **509-5984**



24V

WHEEL LOADER  
DUMP TRUCK  
Models:  
414-436,  
714-726

**Sanden SD7H15**  
Part # **509-632**



24V

BACKHOE/  
LOADALL/  
HANDLER  
Models:  
2CX-4CX,  
531-550

**Sanden SD7H15**  
Part # **509-642**



WHEEL  
LOADER  
Models:  
416, 416HT

**Sanden SD7H15**  
Part # **509-6424**

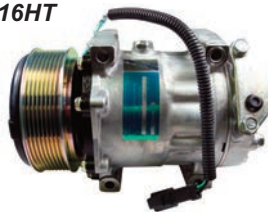

24V

TRACTOR  
Models:

2155,  
2170,  
3200,  
3230,  
7170,  
7200,  
7230,  
7270

**Sanden SD7H15**  
Part # **509-5986**



## Evaporators

LOADALL/HANDLER  
**590-5110**  
Models: 526-540

LOADALL  
**590-5111**  
Models: 520-528S

BACKHOE  
**590-5118**  
Models: 2CX-4CX

WHEEL LOADER  
**590-5120**  
Models: 411-456

WHEEL LOADER Part # **590-5122**

Models:  
426-456



LOADALL/HANDLER  
**590-5130**  
Models: 530-550, SXL530, SXL540

EXCAVATOR  
**590-5150**  
Models: JS130-JS330



## Expansion Valves

### BACKHOE/LOADALL/EXCAVATOR

Models:  
210, 212,  
520-550,  
JS130-JS220,  
TM180, TM220



Part # **903-700**

### BACKHOE

Models:  
214



Part # **903-725**

### EXCAVATOR

Models:  
JZ145, JZ235,  
JZ255



Part # **903-737**

### DUMP TRUCK

Models:  
718, 722



Part # **905-925**

## Receiver Drier/Accumulators

### EXCAVATOR

Models:  
LS130

Part # **800-114**



### WHEEL LOADER

Models:  
411-456B

Part # **800-118**



### LOADALL

Models:  
520-528S

Part # **800-1262**



### LOADALL/HANDLER

Models:  
526-540

Part # **800-151**



### BACKHOE

Models:  
210, 212

Part # **803-324**



### BACKHOE/HANDLER

Models:  
210-217,  
535-550

Part # **803-328**



### BACKHOE

Models:  
215E

Part # **803-459**



### SKIDSTEER

Models:  
T190

Part # **804-698**



### BACKHOE







Models:  
215E

Part # **805-610**

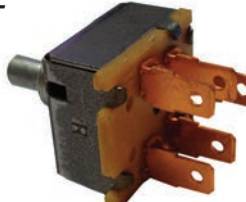



## Switches/Electrical

<p><b>Blower Speed Switch</b>  <b>Part # 205-101</b>                  Models: 535-125 - 540-170</p> 	<p><b>Blower Speed Switch</b>  <b>Part # 205-102</b>                  Models: 535-125 - 540-170</p> 	<p><b>Thermostatic Switch</b>  <b>Part # 210-906</b>                  Models: RTFL</p> 
<p><b>Thermostatic Switch</b>  <b>Part # 210-927</b>                  Models: RTFL</p> 	<p><b>Thermostatic Switch</b>  <b>Part # 210-9631</b>                  Models: 210-217, 520-541</p> 	<p><b>Low Pressure Switch N/O</b>  <b>Part # 220-1038</b>                  Models: 804, 805</p> 
<p><b>Low Pressure Switch N/O</b>  <b>Part # 220-3047</b>                  Models: 210-212, 2CX, 714-722, JS145- JS330</p> 	<p><b>12V Relay, 5 Terminal</b>  <b>Part # 550-270</b>                  Models: 214-550, 2CX-4CX, 8025-8085, TM108, TM220</p> 	<p><b>Heater Control Valve</b>  <b>Part # 570-335</b>                  Models: 531-70, 540, 550</p> 

## AP "Air Combs"

- Great for all air filters, radiators and condensers
- Powerful 90° air flow
- Focused, high-pressure output
- 5X the air volume
- Access hard-to-reach areas
- Extends system life



**12" Air Comb P/N 530-6012**

**24" Air Comb P/N 530-6024**

**36" Air Comb P/N 530-6036**

**48" Air Comb P/N 530-6048**

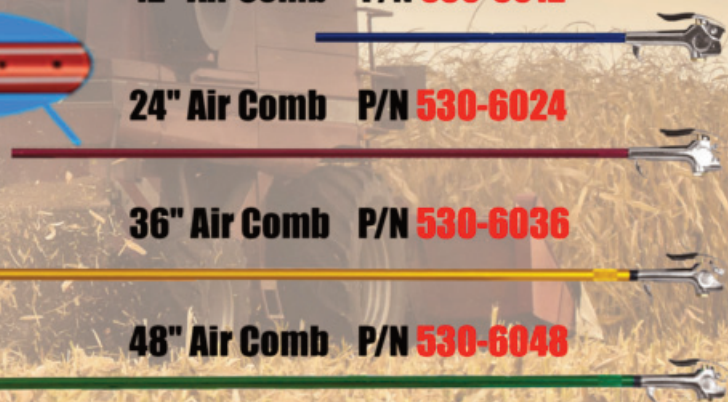
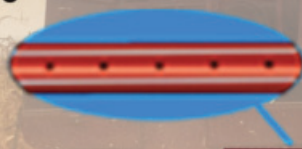



# JOHN DEERE

## Blower Motors

### LOADER/SKIDDER/BACKHOE

Models: **Part # BM11201**  
 310C-610C,  
 310G-710G,  
 310SG,  
 315SG,  
 540E-748E,  
 540G-748G



### WHEEL LOADER

Models: **Part # BM11212**  
 544G, 624G,  
 644G



### BACKHOE

Models: **Part # BM11238**  
 300D-710D



### BACKHOE/LOADER/SKIDDER

Models: **Part # BM112452**  
 210C-710C,  
 344E-644E,  
 444D-644D,  
 410B-710B,  
 643



### LOADER/FORKLIFT

Models: **Part # BM112594**  
 444H-644H,  
 444J-844J,  
 444JR,  
 TC44H-  
 TC62H



### SKIDDER

Models: **Part # BM112602**  
 360D-560D,  
 360DC,  
 460DC,  
 360DG,  
 460DG,  
 540G-748G,  
 540H-848H,



### LOG LOADER

Models: **Part # BM112603**  
 335C-437C,  
 335D,437D,  
 437E



### CRAWLER

Models: **Part # BM11261**  
 655-855,  
 655B-850B,  
 755A



### WHEEL LOADER

Models: **Part # BM11262**  
 644ER,  
 644EZ



### MOTOR GRADER

Models: **Part # BM12411**  
 770A,  
 770BH,  
 772A



### CRAWLER

Models: **Part # BM12412**  
 750C, 850C,  
 750C-II,  
 850C-II

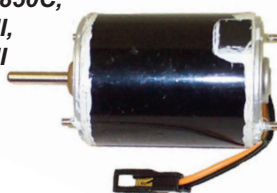

### CRAWLER

Models: **Part # BM124121**  
 7570B,  
 850B,  
 750C-II,  
 850C-II,  
 755, 850



### LOADER/GRADER

Models: **Part # BM12421**  
 444K-844K,  
 670D-872D,  
 670G-872G,  
 670GP-  
 872GP,



### SKIDSTEER

Models: **Part # BM20008**  
 7775, 8875



### BACKHOE

Models: **Part # BM200091**  
 300D-710D,  
 310E-410E,  
 310SE,  
 315SE,



### BACKHOE/LOADER/SKIDDER

Models: **Part # BM20052**  
 310C-610C,  
 344E-644E,  
 410B, 510B,  
 740A

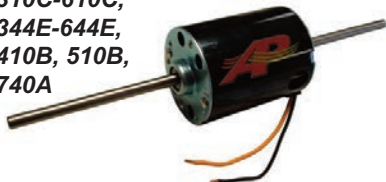

### BACKHOE/LOADER/SKIDDER

Models: **Part # BM20052HD**  
 310C-610C,  
 344E-644E,  
 410B, 510B,  
 740A



### BACKHOE/LOADER/SKIDDER

Models: **Part # BM20052HDK**  
 310C-  
 610C,  
 344E-  
 644E,  
 410B,  
 510B,  
 740A



JOHN DEERE



# JOHN DEERE

## Blower Motors

JOHN DEERE

### SKIDDER/LOADER/BUNCHER

Models: **Part # BM20033**

540E-748E,  
540G-843G,  
643D



### LOADER/GRADER/SCRAPER

Models: **Part # BM20053**

644ER, 644EZ,  
670B-862B,  
762, 862, 844,  
762A-772A,  
770BH,  
772BH



### EXCAVATOR

Models: **Part # BM24223**

110, 120,  
160LC



### CRAWLER

Models: **Part # BM26941**

655-855,  
655B-850B,  
755A



### EXCAVATOR

Models: **Part # BM3832**

135C RTS,  
225CLC RTS,  
225DLC,  
75C, 80C,  
75D, 85D,  
135d



### TELESCOPIC HANDLER

Models: **Part # BM3915**

3200-3800



### EXCAVATOR

Models: **Part # BM3916**

450LC,  
550LC,  
750



### SKIDSTEER

Models: **Part # BM4015**

240-332,  
318D-333D,  
318E-333E,  
CT315,  
CT322,  
CT332



### FELLER BUNCHER

Models: **Part # BM4015-24**

608B, 608L,  
608S, 703G-  
953G,  
703JH-  
909JH,  
753GL, 753J-  
959J, 850-950



### BACKHOE/LOADER/CRAWLER

Models: **Part # BM4037**

210C-710C,  
410B-862B,  
444CH,  
444D-643D,  
450G-650G,  
544E-644E



### LOADER/GRADER/SCRAPER

Models: **Part # BM4037-24**

644ER, 644EZ,  
670B-862B,  
762, 862, 844,  
762A-772A,  
770BH,  
772BH



### CRAWLER

Models: **Part # BM4040**

700H, 700J,  
750J, 850J



### CRAWLER

Models: **Part # BM4041**

1050C,  
605C,  
655C,  
755C,  
950C



### FORWARDER

Models: **Part # BM40625**

1110D,  
1410D,  
1458,  
1710D,  
810D



### MOTOR GRADER

Models: **Part # BM40628**

670C, 770C,  
670CH-  
772CH



### TRACTOR

Models: **Part # BM112601**

7630-9630,  
8210T-9630T

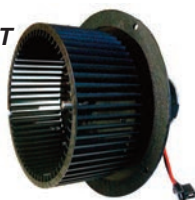

### TRACTOR

Models: **Part # BM11256HD**

8100-8410,  
8100T-  
8400T



### TRACTOR

Models: **Part # BM3895**

2204,  
7185J-7225J,  
7210-9630,  
8100T-9630T



1-800-806-5312



# JOHN DEERE

## Compressors

### A6/Delco to 10PA20HD Denso Style Conversion Kit

Part # **500-013**



A6/Delco

Part # **500-075**



10PA20HD

Models:  
672GP, 690ELC  
700H-700K,  
703G-703JH,  
710D, 710G,  
724J, 724K,

vs.

#### Benefits of 10PA20HD

- New Heavy Duty A6/Delco Replacement with 7" Clutch
- Uses Original Hoses and Belts
- Replaces 10 & 2 o'clock Coil Positions
- Includes HD Dust Protection
- Old 6 Piston vs. New 10 Piston which Requires Less HP for Greater Efficiency

**MOTOR GRADER/LOADER**  
**HD A6 Replacement**  
Part # **500-0752**  
Models:  
770A-772A, 444, 44B-646B, 644XC  
w/ Switch Kit

**BACKHOE/LOADER**  
**Denso 6E171**  
Part # **503-116**  
Models:  
300D-510D, 310C-610C, 310D-510D, 344E-748E, 444D, 544D, 644G

**BACKHOE/LOADER**  
**Denso 6E171**  
Part # **503-1162**  
Models:  
300D-510D, 310C-610C, 310D-510D, 344E-748E, 444D, 544D, 644G

**EXCAVATOR/GRADER**  
**Denso 6E171**  
Part # **503-1164**  
Models:  
595, 595D, 670B, 672B, 690ELC, 770B, 772B, 770BH, 772BH, 892DLC  
**24V**

**BACKHOE/LOADER/SKIDDER**  
**Sanden Style Denso 6E171**  
Part # **503-117**  
Models:  
310D-510D, 344E-748E, 410B, 410C-610C, 410D, 444D-644D,

**TELESCOPIC HANDLER**  
**OE Denso 10PA15C**  
Part # **503-120**  
Models:  
3200-3800

**DUMP TRUCK**  
**OE Denso 10PA15C**  
Part # **503-1214**  
Models:  
350D, 400D

**SKIDSTEER**  
**OE Denso 10PA15C**  
Part # **503-1216**  
Models:  
318D-333D

**EXCAVATOR**  
**OE Denso 10PA15C**  
Part # **503-122**  
Models:  
200LC-550LC, 230LCR, 330LCR, 230LCRD, 370  
**24V**

**EXCAVATOR**  
**OE Denso 10PA15C**  
Part # **503-124**  
Models:  
120C, 800C, 160CLC, 180CW, 450CLC, 450DLC, 600CLC, 650DLC  
**24V**

**BACKHOE/LOADER/GRADER**  
**OE Denso 10PA17C**  
Part # **503-130**  
Models:  
300D-710D, 544G-644G, 450H-650H, 770B, 772B, 770BH, 772BH

**BACKHOE**  
**OE Denso 10PA17C**  
Part # **503-135**  
Models:  
300D-710D

**SKIDSTEER/BACKHOE**  
**OE Denso 10PA17C**  
Part # **503-140**  
Models:  
240-332, 310E-410E, 310G-748G, 310J-843J, 410D-710D, 450H-848H

**WHEEL LOADER**  
**OE Denso 10PA17C**  
Part # **503-1431**  
Models:  
744J, 824J, 744H  
**24V**

**LOG LOADER**  
**OE Denso 10PA17C**  
Part # **503-144**  
Models:  
335D, 437D, 450D

JOHN DEERE



# JOHN DEERE

## Compressors

JOHN DEERE

**FORWARDER/  
BUNCHER**  
Models:  
1010D-1710D,  
1010E-1910E,  
608B, 762B,  
608L, 608S,  
703G-953G,  
703J-959J,  
903K-959K



**TRUCK/  
LOADER/  
GRADER/  
GRADER/**  
Models:  
250D, 300D,  
444H, 700H,  
444J-844J,  
444K-844K,  
670C-770C  
670D-870D



**CRAWLER/  
GRADER/  
LOADER/**  
Models:  
655B-850B,  
670D, 672D,  
750C, 850C,  
750, 770BH,  
772BH,  
774H



**BACKHOE**  
Models:  
310K,  
410K,  
310SK,  
310SL,  
325SL,  
410L



**CRAWLER/  
GRADER/  
TRUCK/  
LOADER**  
Models:  
550K-1050K,  
200D, 300D,  
370E, 410E,  
444K-844K,  
670G-872G



**SKIDSTEER/  
LOG LOADER**  
Models:  
318E-437E



**LOG  
LOADER**  
Models:  
330B-530B,  
335-535,  
335C-437C



**WHEEL  
LOADER**  
Models:  
244J-324J



**EXCAVATOR**  
Models:  
200CLC-  
330CLC,  
75C, 80C,  
370C, 210CW  
135C RTS,  
225CLC RTS,



**EXCAVATOR**  
Models:  
120D,  
135D,  
160DLC-  
350DLC,  
190DW,  
220DW



**EXCAVATOR**  
Models:  
27D,  
35D,  
50D,  
35G,  
50G



**EXCAVATOR/  
LOADER**  
Models:  
110, 120,  
160LC,  
744E



**DUMP  
TRUCK**  
Models:  
350C,  
400C,  
B25C-  
B40C



**CRAWLER**  
Models:  
605C-1050C



**EXCAVATOR**  
Models:  
110, 120,  
160LC



**Manifold Kit Fits Denso 6E171  
Compressor-AP Air Part # 503-116**

Part # 451-1173K

**Manifold Kit Fits Denso 10PA17C  
Compressor-AP Air Part # 503-140 &  
503-145**

Part # 451-1180

**Manifold Kit Fits Denso 10PA17C  
Compressor-AP Air Part # 503-145 &  
503-150**

Part # 451-1185



# JOHN DEERE

## Condenser Fans

Models:  
450H-700H,  
450J-850J

**CRAWLER**

Part # **FA1114-24**



Models:  
605C-1050C,  
555G

**CRAWLER**

Part # **FA7513-24**



## Condensers

**MOTOR GRADER**

Models: Part # **400-5593**  
670B-772B,  
770BH,772BH



**EXCAVATOR**

Models: Part # **400-5594**  
120C, 800C,  
160CLC,  
450CLC,  
180CW,  
450DLC,  
650DLC,  
850DLC



**LOADER/BUNCHER**

Models: Part # **400-5595**  
344E-  
644E,  
444D-  
644D,  
544G-  
644G,  
643, 653E



**EXCAVATOR**

Models: Part # **400-5596**  
75D-135D,  
160DLC-  
350DLC,  
190DW



**SKIDSTEER**

Models: Part # **400-5600**  
317-332,  
CT322,  
CT332



**MOTOR GRADER**

Models: Part # **400-5605**  
670D-872D



**CRAWLER**

Models: Part # **400-5990**  
450H-650H,  
450J-650J



**CRAWLER**

Models: Part # **400-5991**  
450H-700H,  
450-850J



**EXCAVATOR/LOADER**

Models: Part # **400-9100**  
110,120,  
160LC,  
844J



## Evaporators

**WHEEL LOADER**

Models: Part # **590-5650**  
244J-344J,  
244K-344K



**SKIDSTEER**

Models: Part # **590-5673**  
317-332,  
CT322,  
CT332



**SCRAPER/GRADER**

Models: Part # **590-5687**  
762, 862,  
762A-772A,  
762B-862B



**SKIDSTEER**  
**590-5640**

Models: 317-332, CT322, CT332

**EXCAVATOR/LOADER/SWING MACHINE**  
**590-5642**

Models: 200CLC, 210CW, 2054, 2154, 2154D-2954D

JOHN DEERE



# JOHN DEERE

## Evaporators

### LOADER/TOOL CARRIER

Models: **Part # 590-5688**  
 44H-744H,  
 TC44H,  
 TC54H,  
 TC62H

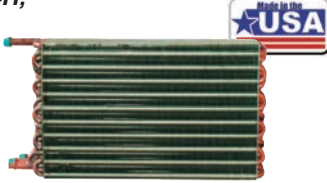

### TELESCOPIC HANDLER

Models: **Part # 590-5689**  
 3800



### BACKHOE/LOADER

Models: **Part # 590-5695**  
 310G-710G,  
 310J, 410J,  
 310K,  
 310SG,  
 315SG,  
 310SJ,  
 644K-724K

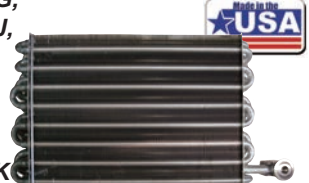

### FORWARDER/EXCAVATOR

**590-5688**

Models: 1510E, 1710D, 1910E, 160CLC-200CLC



### SKIDSTEER/T.HANDLER/BACKHOE

**590-5695**

Models: 318E-326E, 3200-3220, 325SL



### EXCAVATOR/SKIDSTEER

**590-5689**

Models: 200DLC-240DLC, 240, 250



### SKIDSTEER/EXCAVATOR/T.HANDLER

**590-5696**

Models: 326E-333E, 330C-330LCR, 3400-3420



## Heater Cores/Heater Valves

### SKIDSTEER

Models: **Part # 590-5605**  
 240-270



### EXCAVATOR/BACKHOE/LOADER/SKIDDER

Models: **Part # 590-5608**  
 892DLC,  
 310G-748G,  
 444C-644C,  
 540E-748E,  
 544B-646B

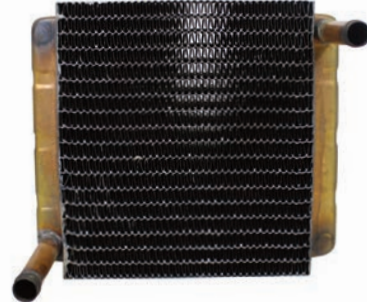

### WHEEL LOADER

Models: **Part # 590-5610**  
 344E, 444E,  
 444D, 544D,  
 544C,  
 644C,  
 844

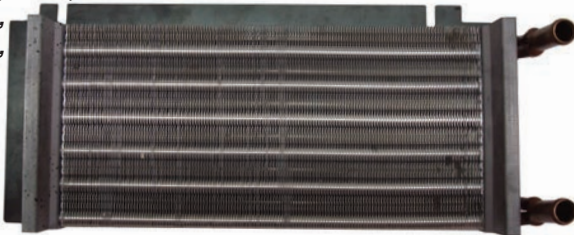

### BACKHOE/SKIDDER/LOADER

Models: **Part # 590-5612**  
 210C-610C,  
 410B, 510B, 540E-748E,  
 540G-843G,



### BACKHOE/LOADER/GRADER

Models: **Part # 570-350**  
 300D-872D,  
 310E-437E,  
 310G-872G,  
 310J-744J,  
 444H-744H,  
 444K-844K



### TRACTOR

Models: **Part # 570-345**  
 624G-646B,  
 640G-III, 643H

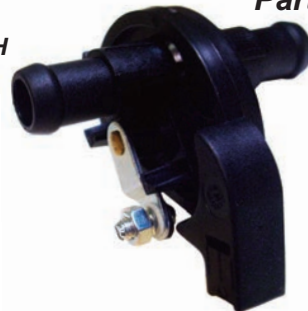



# JOHN DEERE

## Expansion Valves

### LOADER/CRAWLER/GRADER

Models:  
344E, 444E,  
444C-644C,  
444D-644D,  
655,844,  
850, 770A,  
772A, 770B,  
7772B

Part # **902-210**



### CRAWLER/SCRAPER/GRADER

Models:  
655B-862B,  
750-862,  
762A,  
770BH,  
772BH

Part # **902-212**



### BACKHOE/LOADER/GRADER

Models:  
310C-610C,  
410B-862B,  
544E-644E,

Part # **902-219**

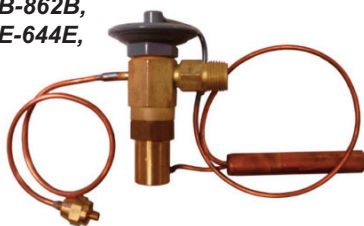

### LOADER/TRUCK/BUNCHER

Models:  
2154-3554,  
250C-350C,  
250D-400D,  
643H, 643J,  
653G, 753G,  
810D, 843H

Part # **903-700**



### EXCAVATOR/BACKHOE/SKIDDER

Models:  
110, 120,  
300D-710D,  
540E-653E,  
540G-748G

Part # **903-705**



### SKIDSTEER

Models:  
318D-333D,  
318E-333E

Part # **903-712**



### CRAWLER

Models:  
200LC-  
550LC,  
230LCR,  
330LCR,  
370, 750

Part # **903-715**



### BACKHOE/LOADER/CRAWLER

Models:  
300D-410D,  
310E-410E,  
444H-700H,  
670B-772B,  
670C-850C,  
TC44H-  
TC62H

Part # **903-725**



### BACKHOE/SKIDSTEER/LOADER

Models:  
310G-872G,  
310J-744J,  
310K-850K,  
544H-848H,  
560D-872D

Part # **903-727**



### CRAWLER/T. HANDLER

Models:  
605C-  
1050C,  
950J,  
3200-3420

Part # **903-745**



### SKIDSTEER

Models:  
240-332,  
CT322,  
CT332

Part # **903-748**



### EXCAVATOR/LOADER

Models:  
75G-135G,  
200CLC-  
270CLC,  
210GLC-  
870GLC,  
2154D-  
3754D

Part # **903-758**



### EXCAVATOR

Models:  
120D,  
160DLC,  
190DW,  
200DLC,  
220DW,  
240DLC-  
350DLC

Part # **903-761**



### EXCAVATOR

Models:  
120C,  
160CLC,  
180CW,  
450CLC,  
450DLC,  
650DLC,  
800C, 850DLC

Part # **903-835**



JOHN DEERE



# JOHN DEERE

## Receiver Driers/Accumulators

JOHN DEERE

### FORWARDER

Models: **Part # 800-156**  
1010E-1910E



### LOADER/SWING MACHINE

Models: **Part # 803-318**  
310C-510C, 444D, 544D, 770A, 772A, 850B



### SKIDSTEER

Models: **Part # 803-322**  
240-328



### FORWARDER/LOADER/BUNCHER

Models: **Part # 803-324**  
1010D-1710D, 330B-608B, 335-950, 335C-437C, 753G-953G



### SWING MACHINE

Models: **Part # 803-3246**  
2154D-3754D



### TRUCK/BUNCHER

Models: **Part # 803-3272**  
250C-400C, 250D-400D, B25C-B40C, 643J, 843J



### EXCAVATOR

Models: **Part # 803-329**  
110, 120, 160LC



### CRAWLER/LOADER

Models: **Part # 803-355**  
605C-1050C, 244J-344J, 244K-344K, 950J



### BACKHOE/SKIDSTEER

Models: **Part # 803-440**  
310J, 410J, 310SJ, 318D-333D, 318E-333E



### MOTOR GRADER

Models: **Part # 803-465**  
670C, 670CH-772CH, 670D-872D, 670G-872G, 670GP-872GP



### BACKHOE/SKIDSTEER

Models: **Part # 804-532**  
300D-872D, 310C-850C, 310E-748E, 310G-872G, 310K-850K, 317-332



### TELESCOPIC HANDLER

Models: **Part # 804-544**  
3800



### T.HANDLER/LOADER/CRAWLER

Models: **Part # 804-550**  
3200-3420, 444-844, 655-855



### FELLER BUNCHER

Models: **Part # 805-610**  
703G, 753G, 75GL, 853J



### EXCAVATOR

Models: **Part # 805-963**  
75D-135D, 160DLC-350DLC, 190DW, 220DW



### EXCAVATOR

Models: **Part # 805-694**  
135C RTS, 200CLC-330CLC, 75C, 80C, 370C



### EXCAVATOR

Models: **Part # 805-700**  
200LC-330LC, 450CLC, 600CLC, 450DLC, 450LC, 650DLC, 800C, 850DLC





# JOHN DEERE

## Switches/Electrical

### 3 Speed Blower Switch

Models:

210C-710C,  
344E, 444E,  
410B-850B,  
444C-644C,  
444D-644D,  
444-862

Part # **205-102**



### 3 Speed Blower Switch

Models:

350C, 400C,  
400D, 535,  
544D, B35C,  
B40C

Part # **205-103**



### 3 Speed Blower Switch

Models:

210C-850C,  
300D-710D,  
3200-3800,  
450G-650G,  
540E-748E,  
670CH-772CH,  
655B-862B

Part # **205-107**

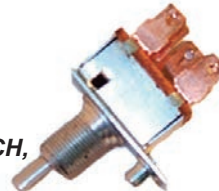

### 3 Speed Blower Switch

Models:

310G-770G,  
310SG, 315SG,  
318D-560D,  
318E-332E,  
3800, TC44H,  
550K-850K,  
444K-844K,

Part # **205-108**



### 3 Speed, 7 Prong Wiper Switch

Models:

444H-744H,  
550J-850J,  
TC44H,  
TC62H

Part # **205-1342**



### Thermostatic Switch

Models:

310G, 410G,  
310SG, 315SG,  
672B-862B,  
672CH-772CH,  
710C-850C,  
740E, 748E,  
750-862

Part # **205-442**



### Rocker Switch

Models:

544H,  
TC44H,  
TC54H

Part # **206-670**



### Thermostatic Switch

Models:

310C-644C,  
344E-644E,  
410B, 510B,  
444D-544D,  
655-850,  
892DLC

Part # **210-906**



### Thermostatic Switch

Models:

670B-862B,  
762-862,  
762A-772A,  
770BH,  
772BH

Part # **210-913**

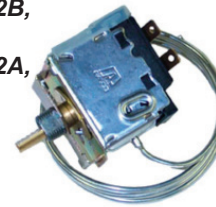

### Thermostatic Switch

Models:

310SJ,  
544H

Part # **210-9376**



### Thermostatic Switch

Models:

3200-3420

Part # **210-953**



### Thermostatic Switch

Models:

120D,  
160DLC,  
190DW,  
200DLC-  
350DLC

Part # **210-985**



## LED/HD Lights

LED Spot Beam 4.5"  
Semi Round Light



3600 Lumens, 35 Watts  
Part # **3-3450**

6900 Lumens, 50 Watts  
Part # **3-3454**

LED Amber Warning Light  
Part # **3-8500**



LED Multi Function  
Warning Light



Part # **3-8956**

LED Flood Beam 4.5"  
Semi Round Light



5000 Lumens, 35 Watts  
Part # **3-3456**

6900 Lumens, 50 Watts  
Part # **3-3455**

JOHN DEERE



# JOHN DEERE

## Switches/Electrical

JOHN DEERE

### S6 Low Voltage Protection Kit

Models:  
762, 762B,  
770A, 772A

Part # **220-053**

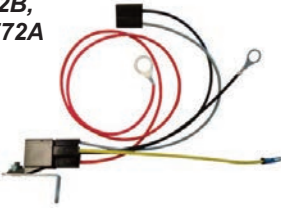

### Clutch Saver Kit

Models:  
310C-610C,  
410B, 510B,

Part # **220-055**

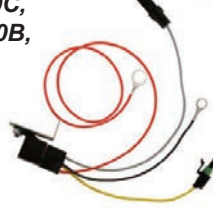

### Low Voltage Protection Kit

Models:  
1710D,  
240-332,  
300D-710D,  
310E-748E,  
310G-872G,  
310J-843J,  
744H, 843H

Part # **220-056**



### Binary Pressure Switch N/O

Models:  
250D-400D,  
370E-460E,  
608B, 608L,  
608S 703G-  
953G, 703J-  
959J, 850-950

Part # **220-10315**



### Binary Pressure Switch N/O

Models:  
310G-770G,  
310J-850J,  
310K-850K,  
317-332,  
318D-872D,  
326E-332E,  
410G-770G

Part # **220-1032**



### Binary Pressure Switch N/O

Models:  
3200-3800

Part # **220-1050**



### A6 Superheat Switch

Models:  
770A,  
772A

Part # **220-239**



### High Pressure Switch N/C

Models:  
300D-710D,  
310C-610C,  
410B-862B,  
540E-748E,  
540G-748G,  
762-862

Part # **220-3014**



### High Pressure Switch N/C

Models:  
75G

Part # **220-3015**



### Low Pressure Switch N/O

Models:  
300D-510D,  
310E-410E

Part # **220-3025**

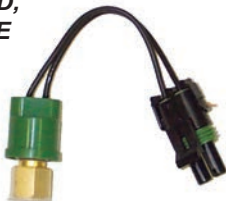

### Low Pressure Switch N/O

Models:  
300D-710D,  
310C-610C,  
410B-862B,  
444H, 540G-  
748G, 540E-  
748E

Part # **220-3026**



### Binary Switch N/O

Models:  
310G-710G,  
315D-872D,  
444H-744H,  
444J-850J,  
750C-850C,  
670B-772B,  
TC44H-TC62H

Part # **220-3081**



### High Pressure Switch N/C

Models:  
300D-872D,  
310E-653E,  
310G-710G,  
444H-744H,  
444J-850J,  
670B-772B,  
670C-850C

Part # **220-3089**



### Binary Switch N/O

Models:  
330C LC

Part # **220-424**



### Binary Switch N/O

Models:  
75D-135D,  
330C LC,  
220CLC-  
270CLC,  
160DLC,  
350DLC,  
135C RTS

Part # **220-432**



### Binary High Pressure

Models:  
120C-800C,  
160CLC-  
450CLC,  
250GLC-  
870GLC,  
200LC-550LC,  
450DLC-850DLC

Part # **220-506**



### Blower Speed Resistor

Models:  
360DC, 460DC,  
360DG, 460DG,  
560D, 848H,  
540G-II,  
548G-II,  
540G-III,  
748G-III

Part # **220-524**

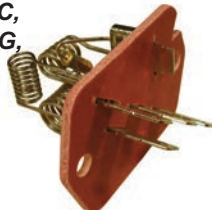

### Blower Speed Resistor

Models:  
410C-610C,  
643-862,  
644E, 892DLC,  
670B-862B,  
762A-772A,  
770BH, 772BH,

Part # **220-529**





# JOHN DEERE

## Switches/Electrical

### Blower Speed Resistor

Models: **Part # 220-531**  
350C, 400C,  
B35C, B40C



### Thermo-Disc Switch

Models: **Part # 220-533**  
844



### Blower Speed Resistor

Models: **Part # 220-543**  
700H



### Blower Speed Resistor

Models: **Part # 220-544**  
450H-650H,  
450J-650J



### Blower Speed Resistor

Models: **Part # 220-548**  
540E-748E,  
540G-843G,  
643D



### Blower Speed Resistor

Models: **Part # 220-554**  
3200-3420

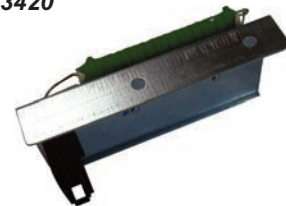

### Blower Motor Electromagnetic Interference Filter

Models: **Part # 220-614**  
450H-700H,  
450J-850J



### Thermostatic Switch

Models: **Part # 220-983**  
3800



## Oil Coolers

### MOTOR GRADER

Models: **Part # 5-5508**  
770B, 772B,  
770BH,  
772BH



### LOADER/CRAWLER/GRADER

Models: **Part # 5-5509**  
644G, 750C,  
770B, 772B,  
770BH,  
772BH,  
792DLC,  
850C,  
892ELC



### SKIDSTEER

Models: **Part # 5-5540**  
317, 320



### BACKHOE

Models: **Part # 5-5550**  
300D-315D



### BACKHOE

Models: **Part # 5-5551**  
310C, 315C



### BACKHOE

Models: **Part # 5-5552**  
410B, 510B,  
410C, 510C

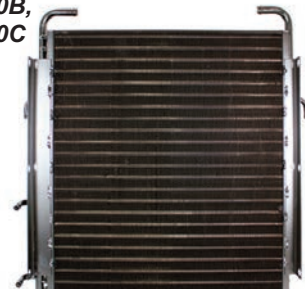



# JOHN DEERE

## Oil Coolers

JOHN DEERE

**BACKHOE**  
Models: **Part # 5-5553**  
410D, 510D



**BACKHOE**  
Models: **Part # 5-5554**  
410D, 510D



**EXCAVATOR**  
Models: **Part # 5-5560**  
690ELC



**LOADER/SKIDDER**  
Models: **Part # 5-5570**  
444H-554H,  
540E-748E,  
540G-748G,  
560D



**SKIDSTEER**  
Models: **Part # 5-5575**  
325,  
328,  
332



**LOADER/TOOL CARRIER**  
Models: **Part # 5-5580**  
444H, 544H,  
TC44H,  
TC54H



**LOADER/TOOL CARRIER**  
Models: **Part # 5-5581**  
444H, 544H,  
TC44H,  
TC54H



**WHEEL LOADER**  
Models: **Part # 5-5582**  
444D,  
544D,  
644D



**WHEEL LOADER**  
Models: **Part # 5-5583**  
544E, 624E,  
544G, 624G



**LOADER/TOOL CARRIER**  
Models: **Part # 5-5584**  
624H,  
TC62H



**LOADER/TOOL CARRIER**  
Models: **Part # 5-5585**  
624H,  
TC62H



**LOADER/TOOL CARRIER**  
Models: **Part # 5-5586**  
624H,  
TC62H



**BUNCHER/LOADER**  
Models: **Part # 5-5587**  
643, 643D,  
644D, 644E,  
644ER,  
644EZ,  
644G



**WHEEL LOADER**  
Models: **Part # 5-5588**  
744H



**CRAWLER**  
Models: **Part # 5-5590**  
450G-650G



**CRAWLER**  
Models: **Part # 5-5591**  
450G-650G

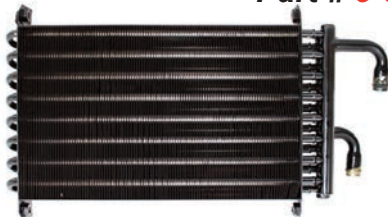

**BACKHOE**  
Models: **Part # 5-5596**  
310K, 410K,  
310SJ, 310SK,  
310SL, 325SL,  
410J, 410K,  
410L





# JOHN DEERE

## Conversion Kits

### A6 TO SANDEN CONVERSIONS

Models:  
762, 762B

Part # **990-4034**

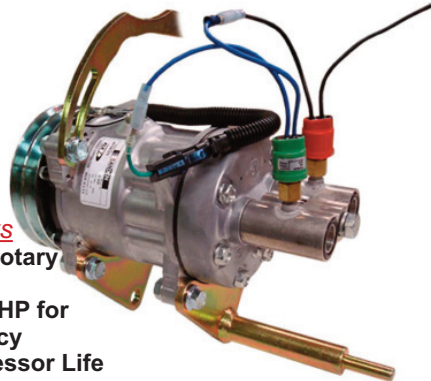

Sanden Benefits

- New 7 Piston Rotary Compressor
- Requires Less HP for Greater Efficiency
- Longer Compressor Life

Part # **995-436**

A6-Sanden Universal Bracket

New Patented Design Allows Sanden Style Compressor to Replace all A6 Mounted Compressors

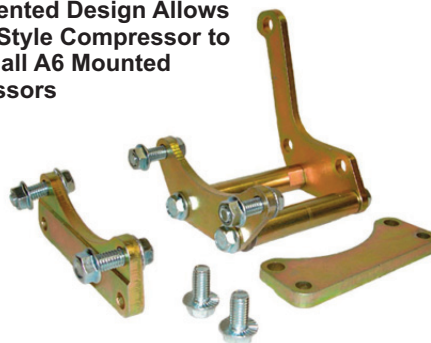

## Engine Fans

### TELESCOPIC HANDLER

Models:  
3215,  
3415

Part # **EF5842**



### TRACTOR

Models:  
9300-9520,  
9300T-9520T

Part # **EF5860**



### TRACTOR

Models:  
9620,  
9620T

Part # **EF5862**



## Tractor-Fan Clutches

Models:  
8300, 8400  
Early S/N

Part # **FC1500**



Models:  
7710, 7810

Part # **FC1501**



Models:  
4050-4450,  
4055-4455,  
8100-8400,  
8100T-8400T

Part # **FC1502**



Models:  
6100-6500,  
6200L-6500L,  
SE6100-  
SE6400

Part # **FC1503**



Models:  
4455-4955,  
4560-4960,  
4650-4850

Part # **FC1505**



Models:  
6010-7510,  
6405-7405,  
6110L-6510L,  
SE6010-  
SE6610

Part # **FC1507**





# JOHN DEERE

## Tractor-Fan Clutches

JOHN DEERE

Models:  
8410, 8410T,  
8420, 8420T

Part # **FC1508**



Models:  
7630, 7730,  
7830, 7930

Part # **FC1509**



Models:  
8100-8400,  
8100T-8400T,  
8110-8310,  
8110T-8310T

Part # **FC1510**



Models:  
8100, 8200

Part # **FC1512**



Models:  
6910, 6910S

Part # **FC1514**



Models:  
8850, 8960

Part # **FC1515**



Models:  
8560, 8760,  
8770, 8870

Part # **FC1516**



Models:  
7200R, 7215R,  
7230R, 7260R,  
7280R Early  
S/N's

Part # **FC1517**



Models:  
9120, 9220

Part # **FC1518**



Models:  
8120-8520,  
8120T-8520T

Part # **FC1519**



Models:  
2250-2850,  
2355-2755

Part # **FC1520**



Models:  
6230, 6330,  
6430

Part # **FC1521**



Models:  
9120-9620  
9320T-9620T

Part # **FC1522**



Models:  
9100, 9200

Part # **FC1523**



Models:  
7700, 7800

Part # **FC1524**



Models:  
8970

Part # **FC1528**



Models:  
7820, 7920

Part # **FC1530**



Models:  
2955, 3050,  
3055, 3150,  
3350

Part # **FC1540**

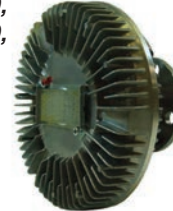

1-800-806-5312



# JOHN DEERE

## Radiators

### LOADER/BACKHOE/FORKLIFT

Models:  
300B, 301A, 302,  
400, 401M, 401B,  
401C, 302A, 480



Part # **AR5516**

### SKIDSTEER

Models:  
325, 328, CT322,  
CT332

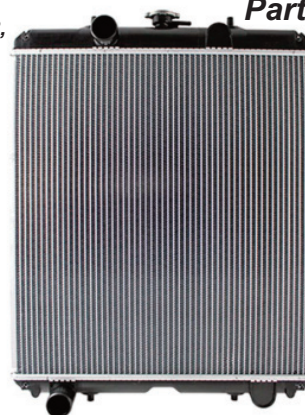

Part # **AR5702**

SKIDSTEER

**AR2847**

Models: 570, 575

SKIDSTEER

**AR5706**

Models: 375, 3375

SKIDSTEER

**AR2848**

Models: 4475, 5575, 6675, 7775

SKIDSTEER

**AR5707**

Models: 317, 320

SKIDSTEER

**AR2850**

Models: 8875

BACKHOE

**AR5710**

Models: 300D, 310C, 310D, 315C, 315D

UTILITY

**AR5508**

Models: 300, 301 w/ Hi-Lo Shift

BACKHOE

**AR5712**

Models: 310E, 310SE, 315SE

UTILITY

**AR5509**

Models: 300, 301 w/o Hi-Lo Shift

BACKHOE

**AR5715**

Models: 410

BACKHOE/FORKLIFT

**AR5519**

Models: 300B, 302A, 380, 480A, 480B

BACKHOE

**AR5720**

Models: 410, 410B, 410D, 415B, 510B-510D, 610B, 610C

TELESCOPIC HANDLER

**AR55821**

Models: 3420

CRAWLER

**AR5722**

Models: 400G, 450B, 450C, 450D, 450E

SKIDSTEER

**AR5700**

Models: 240, 250

FORKLIFT

**AR5723**

Models: 480C

SKIDSTEER

**AR5701**

Models: 260, 270, 280

FORKLIFT/LOADER

**AR5724**

Models: 444J, 444JR, 444K, 524K, 524J, 544K

SKIDSTEER

**AR5703**

Models: 332

BACKHOE

**AR5725**

Models: 500C, 510

BACKHOE/FORKLIFT

**AR5704**

Models: 210C, 482C

SKIDSTEER

**AR5729**

Models: 675, 675B

BACKHOE

**AR5705**

Models: 310A, 310B

SKIDSTEER

**AR5730**

Models: 675, 675B

JOHN DEERE



# CONVERSION KITS

## York To Sanden Conversion Kits

HEAVY DUTY TRUCK CONVERSIONS - COVERS ALL MAKES AND ALL ENGINE MANUFACTURERS

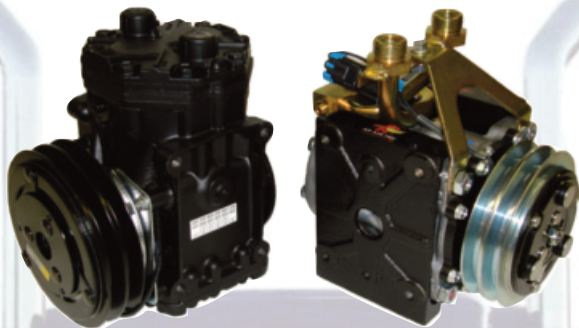

### YORK TO SANDEN

#### **Benefits of Sanden Compressors-**

- \*Improves Cooling Performance
- \*Eliminates Front Seal Failure
- \*Less Vibration On Engine Mounts
- \*7 Piston vs. 2 Piston Design
- \*Allows For Use Of Original Hoses
- \*Compatible w/All Engine Manufacturers
- \*Adapts to All York Applications
- \*Easy Installation
- \*Rugged Cast Iron Designed Mount
- \* #1 Choice of OE Manufacturers

### 60 SERIES DETROIT RELOCATION KIT

#### **991-8009**

60 Series Relocation Kit  
Incl. Compressor/Mount & Hardware

Fits trucks 2004 & older w/passenger side-mounted York compressor. Eliminates York compressor & mount w/OE # 23520826M. Converts to Sanden style mount -relocated on upper timing cover.

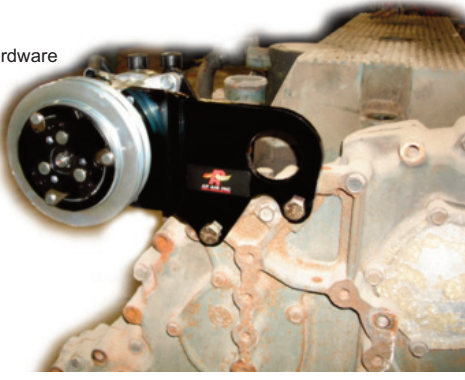

#### **!SAVES COSTLY REPAIRS!**

By Relocating Compressor Mount & Reusing Worn Timing Cover



#### **990-9001**

1 Groove Applications (1/2"-3/4" belt)  
2.75" Gauge Line



#### **990-9002**

2 Groove Applications  
1.66", 2.28" Gauge Line



#### **990-9006**

6 Groove Applications  
2.05" Gauge Line



#### **990-9008**

8 Groove Applications  
1.93" Gauge Line

CONVERSION KITS



# KOBELCO

## Blower Motors

Models:  
SK100-SK400

**EXCAVATOR**

Part # **BM12414**



Models:  
70SR, SK115SRDZ-  
AK480LC, SK80CS,  
ED150, ED150-1E,  
ED190LC

**EXCAVATOR/BLADE RUNNER**

Part # **BM3675**



Models:  
CK1000

**CRANE**

Part # **BM3679**



Models:  
140SR, 80CS,  
ED150-  
ED195-8,  
SK100L-  
SK400LC

**EXCAVATOR/BLADE RUNNER**

Part # **BM3835**



## Compressors

**EXCAVATOR**  
Models:  
SK220

**Upright Denso to Seltec Conversion Kit**

Part # **990-492**

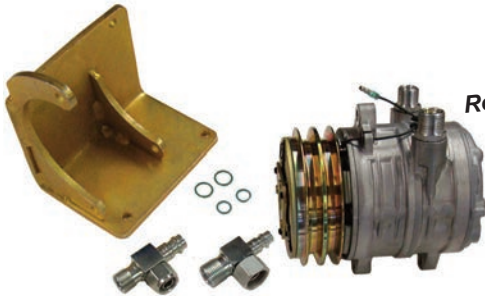

Replaces Upright Style  
Denso Compressor

**24V**

**EXCAVATOR/OE Sanden SD7H13  
BLADE RUNNER**

Part # **509-399**

Models: ED190LC,  
SK210LC-SK480LC



**24V**

**EXCAVATOR**  
Models:  
SK235SR,  
SK75UR

**Sanden SD7H13**

Part # **509-3990**

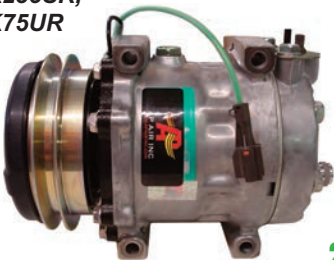

**24V**

**EXCAVATOR/OE Sanden SD7H13  
BLADE RUNNER**

Part # **509-3991**

Models:  
140SR,  
80CS,  
ED150-  
ED195-8,  
SK115-  
SK850



**24V**

**EXCAVATOR/OE Sanden SD7H13  
BLADE RUNNER**

Part # **509-3992**

Models:  
ED190LC,  
SK160LC-  
SK480LC



**24V**

**EXCAVATOR OE Sanden SD5H14**  
Models:  
SK100-  
SK400LC

Part # **509-436**



**24V**

**EXCAVATOR Sanden SD7H15**  
Models:  
SK115-  
SK400LC

Part # **509-5504**



**24V**

**EXCAVATOR SD7H13 Clutch 5.75"**  
Models:  
SK210LC

Part # **600-9764**





**24V**

**KOBELCO**



# KOBELCO

## Condensers

<p><b>EXCAVATOR</b> Part # <b>400-9102</b></p> <p>Models: SK100-SK270</p> 	<p><b>EXCAVATOR</b> Part # <b>400-9104</b></p> <p>Models: SK300, SK400</p> 
---	---





## Expansion Valves

<p><b>EXCAVATOR</b> Part # <b>902-280</b></p> <p>Models: SK2500</p> 	<p><b>EXCAVATOR/BLADE RUNNER</b> Part # <b>903-700</b></p> <p>Models: ED180, SK100-SK400</p> 	<p><b>EXCAVATOR/BLADE RUNNER</b> Part # <b>903-830</b></p> <p>Models: 70SR, ED150, ED190LC, SK115-SK480, SK80CS</p> 
---	--	---

## Expansion Valves

<p><b>EXCAVATOR/BLADE RUNNER</b> Part # <b>802-200</b></p> <p>Models: ED180, SK100-SK400</p> 	<p><b>EXCAVATOR/BLADE RUNNER</b> Part # <b>803-450</b></p> <p>Models: 70SR, ED150, ED190LC, SK115-SK480, SK80CS</p> 	<p><b>EXCAVATOR</b> Part # <b>805-687</b></p> <p>Models: 30SR-3, 35SR, 35SR-5, SK55SRX</p> 
--	---	--

## Radiators

<p><b>EXCAVATOR</b> Part # <b>AR6510</b></p> <p>Models: 27SR-3, 27SR-ACERA, SK20SR, SK20SR-3</p> 	<p><b>EXCAVATOR</b> Part # <b>AR6512</b></p> <p>Models: 30SR, 30SR-2, 35SR, 35SR-3, 35SR-5, SK30UR</p> 	
<p><b>EXCAVATOR</b> Part # <b>AR6514</b></p> <p>Models: 30SR-2, 35SR-2</p> 	<p><b>EXCAVATOR</b> Part # <b>AR6520</b></p> <p>Models: SK160-SK250</p> 	<p><b>EXCAVATOR</b> Part # <b>AR6523</b></p> <p>Models: 30SA-2, 30SR-2, 35SR-2, SK25SR-2</p> 

KOBELCO



# KOMATSU

## Blower Motors

### DUMP TRUCK

Part # **BM3675**

Models:  
HD255-5,  
HM300-2,  
HM350-2,  
HM400-2



### EXCAVATOR

Part # **BM3677**

Models:  
PC200,  
PC200-7,  
PC300LC-7EO



### DOZER/EXCAVATOR

Part # **BM3830**

Models:  
D155A-  
D375A,  
D41E-D85E,  
D41P-D85P,  
D475A,  
PC1250-7



### CARRIER/GRADER/EXCAVATOR

Part # **BM3832**

Models:  
CD110R-2,  
GD555-3-  
GD675-3,  
PC128US-2,  
PC128UU-2



### TRUCK/LOADER

Part # **BM3835**

Models:  
HD325-7 -  
HD785-7,  
WA200-6 -  
WA500-6



### MOTOR GRADER

Part # **BM3840**

Models:  
GD655-3EO



### EXCAVATOR

Part # **BM3850**

Models:  
PC800-7



### SKIDSTEER

Part # **BM3908**

Models:  
CK30-1,  
CK35-1,  
SK1020-5N



## Compressors

BACKHOE  
Models:

### Delphi HR6

Part # **502-040**

WB140-2,  
WB140-2N, WB140PS-2, WB140PS-  
2N, WB150-2, WB150PS-2, WB91R-2-  
WB97R-2, WB97S-2



DOZER/  
TRUCK  
/LOADER  
Models:

### OE Denso 10PA15C

Part # **503-122**

D39-D65EX-  
15, HD325-6,  
WA300

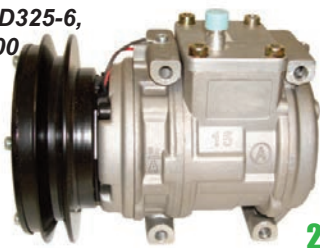

24V

EXCAVATOR/  
LOADER  
Models:

### OE Denso 10PA15C

Part # **503-124**

D155A-D475A, D61PX-D85PX, H205-  
HB215, PC125-PC850, WA100-WA480



24V

DOZER  
Models:

### Denso 2M126B

Part # **503-494**

D65E-12,  
D65EX-12,  
D65PX-12



24V

EXCAVATOR  
Models:

### Seiko-Seiki SS96DL

Part # **504-335**

PC50UU-2,  
PC58UU-2



LOADER  
Models:

### OE Zexel DKS15CH

Part # **506-822**

WA75-3

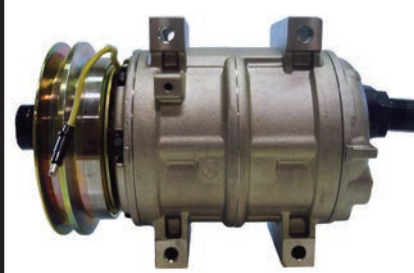

KOMATSU



# KOMATSU

## Compressors

KOMATSU

**EXCAVATOR/GRADER**  
Models:  
GD5553C-  
GD675-3A,  
PC128US-  
PC228US,  
PC78

**OE Zexel DKS15CH**  
Part # **506-850**



24V

**EXCAVATOR/GRADER**  
Models:  
GD555-3-  
GD675-3,  
PC100-6-  
PC450-6

**OE Zexel DKS15CH**  
Part # **506-857**



24V

**EXCAVATOR**  
Models:  
PC100-6-  
PC450-6

**OE Zexel DKS15CH**  
Part # **506-858**



24V

**EXCAVATOR**  
Models:  
PC78US-6

**Zexel DKS15CH**  
Part # **506-860**



24V

**EXCAVATOR**  
Models:  
PC3000-6,  
PC300-6

**OE Sanden SD7H15**  
Part # **506-881**



24V

**SKIDSTEER/EXCAVATOR**  
Models:  
CK30-1,  
CK35-1,  
PC35MR-2,  
PC50MR-2,  
PC95R-2,  
SK1020-5N

**OE Delphi SP10**  
Part # **508-810**



**EXCAVATOR**  
Models:  
PC27MR-2-B,  
PC30MR1C,  
PC35MR-2,  
PC40MR-2,  
PC50MR-2

**Sanden SD7B10**  
Part # **509-371**



**LOADER**  
Models:  
WA200-6-  
WA480-6

**Sanden SD7H13**  
Part # **509-39912**



24V

**LOADER/DUMP TRUCK**  
Models:  
HD325-7-  
HD785-7,  
HM350-2R,  
HM400-2,  
WA500-6

**Sanden SD5H14**  
Part # **509-4301**



24V

**DOZER**  
Models:  
D31EX-22,  
D31PX-22,  
D37EX-22,  
D37PX-22

**OE Sanden SD5H14**  
Part # **509-4302**



24V

**EXCAVATOR**  
Models:  
PC200LC-6-  
PC400LC-6,  
PC50MR-2

**OE Sanden SD5H14**  
Part # **509-436**



24V

**DOZER/LOADER**  
Models:  
D39PX-22,  
D51PX,  
WA120-3-  
WA420-3

**Sanden SD7H15**  
Part # **509-5504**



24V

## Condensers

**EXCAVATOR** Part # **400-6142**

Models:  
PC138-8, PC200-8,  
PC210-8, PW140-7,  
PC220-8, PC220LC-  
8, PC270-8,  
PC300LC-8



**EXCAVATOR/LOADER** Part # **400-6145**

Models:  
PC200-7,  
PC360-7,  
PC400-7,  
PC450-7EO,  
WA600-6,  
WA600-6R



**LOADER/DUMP TRUCK** Part # **400-6148**

Models:  
WA200-6,  
WA200PZ-6,  
WA250-6, WA320-6,  
WA500-6, HM300-2,  
HM350-2R



**DOZER/EXCAVATOR** Part # **400-9010**

Models:  
D61PX-15,  
D85PX-15,  
PC220-7,  
PC270-7,  
PC750-7





# KOMATSU

## Evaporators

**DOZER/EXCAVATOR**  
Part # **590-6140**

Models:  
D155A-6,  
D65PX-16,  
HB205-1,  
HB215LC-1,  
PC130-8-  
PC450LC-8



**EXCAVATOR**  
Part # **590-6143**

Models:  
PC160-7,  
PC200LC-7,  
PC220-7, PC300-7,  
PC350-7,  
PC600LC-7,  
PC800-7,  
PC1250SP-7



**EXCAVATOR/LOADER**  
Part # **590-6145**

Models:  
PC130-7-  
PC850-8R,  
PW140-7,  
WA600-6,  
WA600-6R



**DOZER/TRUCK/LOADER**  
Part # **590-6200**

Models:  
D755-5-S, D75S-5,  
D85C-21-A,  
HD785-5,  
HD985-5,  
WA200-5-  
WA480-5



## Expansion Valves

**DOZER/EXCAVATOR**  
Part # **902-231**

Models:  
D20A-D37P,  
PC100-6-  
PC400-6,  
PC45-PC78



**DOZER/EXCAVATOR**  
Part # **902-280**

Models:  
D155-A3C-  
D575A-3,  
D60P-12-E-  
D85C-21-A,  
PC1600-1,  
PC200-6-  
PC230-6



**DOZER/TRUCK/EXCAVATOR**  
Part # **903-715**

Models:  
D275A-5-  
D475A-3,  
HD605-7,  
HM300-1-  
HM400-1,  
PC1100-6,  
PC160-6-  
PC800-6



**EXCAVATOR/LOADER**  
Part # **903-720**

Models:  
PC1100-6,  
PC1800-6,  
PC200-6-  
PC800-6,  
WA100-3-  
WA900-3,  
WR11-3



**DOZER**  
Part # **903-705**

Models:  
D51PX-22



**DOZER/EXCAVATOR/LOADER**  
Part # **903-750**

Models:  
PC160LC-7,  
PC250-6,  
PC650LC-6,  
WA250-5,  
WA430-5



**DUMP TRUCK**  
Part # **903-830**

Models:  
HD255-5,  
HM300-2-  
HM400-2



**DOZER/EXCAVATOR/LOADER**  
Part # **903-746**

Models:  
D155A-6,  
D65PX-16,  
HB205-1,  
PC130-7-  
PC850-8R,  
WA600-6



**KOMATSU**



# KOMATSU



## Receiver Driers/Accumulators

<p><b>EXCAVATOR</b> Part # <b>800-2278</b></p> <p>Models: HB205-1, HB215-1, PC180-8- PC270-8</p> 	<p><b>EXCAVATOR</b> Part # <b>803-331</b></p> <p>Models: PC300-6, PC300-7</p> 	<p><b>DUMP TRUCK</b> Part # <b>803-450</b></p> <p>Models: HM350-2, HM350-2R, HM400-2, HM400-2R</p> 
<p><b>DOZER/EXCAVATOR</b> Part # <b>805-691</b></p> <p>Models: D275A-2, D575A-2, PC650LC-5, PC650SE-5, PC710-5, PC710SE-5</p> 	<p><b>GRADER/EXCAVATOR/LOADER</b> Part # <b>805-694</b></p> <p>Models: GD555-3- GD675-5, PC128US-2- PC400LC-6, PC78US-8, WA200-6- WA500-6</p> 	<p><b>DOZER/EXCAVATOR/LOADER</b> Part # <b>805-700</b></p> <p>Models: D39-D65EX- 15, PC200, PC220, WA250- WA320</p> 

## Switches/Electrical

<p><b>EXCAVATOR</b> Part # <b>205-103</b></p> <p>Models: PC300-6</p> 	<p><b>SKIDSTEER</b> Part # <b>210-912</b></p> <p>Models: CK35-1, SK102-5N</p> 	<p><b>DOZER/TRUCK/EXCAVATOR</b> Part # <b>550-230</b></p> <p>Models: D275A-5, D375A-5, D65PX-15, D85MS-15, HM350-1, HM400-1, PC200-7- PC45LC-6K</p> 
---	--	--

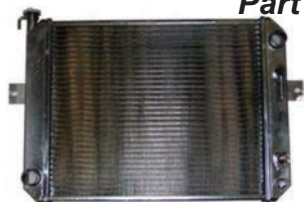
## Radiators

<p><b>FORKLIFT</b> Part # <b>IR36010</b></p> <p>Models: 4-6000</p> 	<p><b>EXCAVATOR</b> Part # <b>IR32060</b></p> <p>Models: PC27R-6, PC27R-8</p> 
<p><b>LOADER</b> <b>IR32016</b> Models: WA430-WA480-5</p>	<p><b>EXCAVATOR</b> <b>IR32020</b> Models: PC200-6 - PC250-6</p>
<p><b>LOADER</b> <b>IR32017</b> Models: WA380-5</p>	<p><b>EXCAVATOR</b> <b>IR32021</b> Models: PC220-6Z - PC240LC-6K</p>
<p><b>LOADER</b> <b>IR32018</b> Models: WA350-3A, WA380-3, WA380-DZ-3</p>	<p><b>EXCAVATOR</b> <b>IR32022</b> Models: PC600, PC600-6, PC600-6LC, PC650</p>
<p><b>LOADER</b> <b>IR32019</b> Models: WA300-3A</p>	<p><b>EXCAVATOR</b> <b>IR32023</b> Models: PC400-7, PC450-7K</p>

KOMATSU



# KUBOTA

## Blower Motors

### EXCAVATOR

Part # **BM12508**

Models:  
KX080-3,  
KX121,  
KX121-3,  
KX161-3



### TRACTOR

Part # **BM3822**

Models:  
B2650-B3350,  
L3240-L5740,  
M5700-M9000



## Compressors

### EXCAVATOR

Denso 10PO8E

Part # **503-180**

Models:  
U35-S2,  
L300-L4610,  
M4900-M9000



### EXCAVATOR

Denso SV07E

Part # **503-183**

Models:  
KX080-3,  
KX121,  
KS121-3,  
KX161-3



### SKIDSTEER

OE Denso SV07E

Part # **503-186**

Models:  
SVL75-2C,  
SVL75C,  
SVL90-2C,  
SVL90C

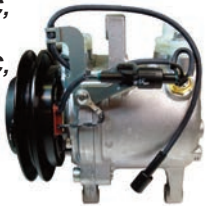

### TRACTOR

OE Denso SCSA06C

Part # **503-170**

Models:  
B3030,  
L3240-  
L5240,  
M95S-  
M9000,  
RTV1100

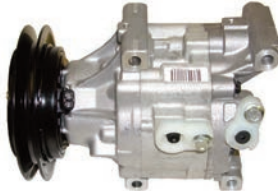

### TRACTOR

OE Denso SCS06

Part # **503-175**

Models:  
M110-  
M9000

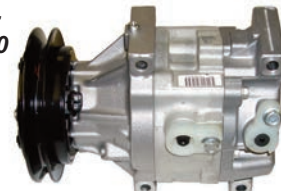

### TRACTOR

OE Denso 10PA15C

Part # **503-1225**

Models:  
M110, M120,  
M7580,  
M8580,  
M9580



### TRACTOR

Denso SV07E

Part # **503-181**

Models:  
M126,  
M135



### TRACTOR

OE Denso SV07E

Part # **503-182**

Models:  
M100,  
M108,  
M110,  
M5040-  
M9540,  
M96



## Condensers

### EXCAVATOR

Part # **400-6008**

Models:  
KX161-3,



### EXCAVATOR

Part # **400-6018**

Models:  
KX080-3,  
KX121,  
KX121-3,  
KX161-3



### SKIDSTEER

Part # **400-6025**

Models:  
SVL75-2C,  
SVL75C, SVL90-2C,  
SVL90C





# KUBOTA

## Condensers

**TRACTOR**  
Part # **400-6004**

Models:  
M4900,  
M5700,  
M6800,  
M8200,  
M9000



**TRACTOR**  
Part # **400-6006**

Models:  
M105,  
M1055,  
M108,  
M4900,  
M5700,  
M6800,  
M8200,  
M9000



**TRACTOR**  
Part # **400-6016**

Models:  
L3240, L3540,  
L3560, L3940,  
L4060, L4240,  
L4740, L4760,  
L5240,  
L5740,  
L6060



## Expansion Valve/Receiver Drier/O-Ring Kit

**EXCAVATOR**  
Part # **903-721**

Models:  
KX080-3,  
KX121,  
KX121-3  
KX161-3

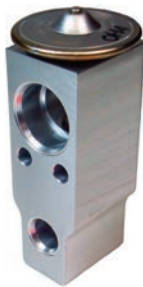

**EXCAVATOR/SKIDSTEER**  
Part # **805-700**

Models:  
KX080-3,  
KX121,  
KX121-3,  
KX161-3,  
SVL75-2C,  
SVL75C,  
SVL90-2C,  
SVL90C,  
U35-S2



Single Application O-Ring Kit  
Part # **530-6050**

With Metric O-Rings



## Switches/Electrical

**EXCAVATOR** Blower Switch with A/C On-Off Control

Models:  
KX161-3,

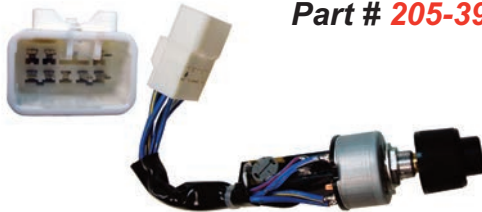

Part # **205-396**

**SKIDSTEER** Preset Electronic Thermostatic Switch

Models:  
SVL75-2C,  
SVL75C,  
SVL90-2C,  
SVL90C,  
KX050-3



Part # **210-969**

**EXCAVATOR** Preset Thermostatic Switch

Models:  
KX121,  
KX121-3,  
KX161-3

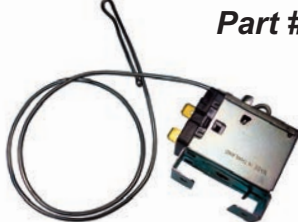

Part # **210-970**

**EXCAVATOR** Binary Pressure Switch N/O

Models:  
KX080-3



Part # **220-430**

## Evaporators

**TRACTOR** Part # **590-6005**

Models:  
L3430-L5030,  
M4900-M9000



**TRACTOR** Part # **590-6011**

Models:  
M100-M135,  
M5040-M9960





# TEREX & LINK-BELT

**TEREX & LINK-BELT**

## Blower Motors

**LINK-BELT EXCAVATOR**  
 Models: 130LX  
 Part # **BM3675**



**LINK-BELT CRANE**  
 Models: HTC8640  
 Part # **BM4015**



**TEREX TRUCK**  
 Models: 3305  
 Part # **BM24223**



**TEREX LOADER**  
 Models: SKL863  
 Part # **BM40152**



**TEREX TRUCK**  
 Models: TA30  
 Part # **BM4024**



## Blower Wheels

**TEREX TRUCK**  
 Models: 3305  
 Part # **BW226**



**TEREX TRUCK**  
 Models: 3305  
 Part # **BW227**



## Compressors

**TEREX CRANE**  
 Models: AC120, AC80  
**Denso 10PA15C**  
 Part # **503-1204**



**24V**

**TEREX CRANE**  
 Models: HC80  
**OE Denso 10PA15C**  
 Part # **503-1206**



**24V**

**TEREX SKIDSTEER**  
 Models: PT50, PT60, PT70, PT80, PT100  
**Seltec TM-16HD**  
 Part # **506-793**



**LINK-BELT EXCAVATOR**  
 Models: 3400  
**OE Sanden SD7H13**  
 Part # **509-399**



**24V**

**LINK-BELT EXCAVATOR**  
 Models: 130LX, 210LX, 240LX, 460LX  
**OE Sanden SD7H13**  
 Part # **509-3991**



**24V**

**LINK-BELT EXCAVATOR**  
 Models: 130LX, 210LX, 240LX, 330LX, 460LX  
**OE Sanden SD7H13**  
 Part # **509-3992**



**24V**



# TEREX & LINK-BELT

## Compressors

LINK-BELT  
EXCAVATOR  
Models:  
3400

**Sanden SD7H13**  
Part # **509-3993**



24V

TEREX  
SKIDSTEER  
Models:  
PT100G

**Sanden SD7H13**  
Part # **509-3999**



TEREX  
TRUCK  
Models:  
TA30

**OE Sanden SD7H15**  
Part # **509-4354**



24V

TEREX  
CRANE  
Models:  
T340

**OE Sanden SD7H15**  
Part # **509-5501**



TEREX  
SCRAPER  
Models:  
TS14F

**Sanden SD7H15**  
Part # **509-5544**



24V

TEREX  
CRANE  
Models:  
T700

**OE Sanden SD7H15**  
Part # **509-5591**



TEREX  
LOADER  
Models:  
750-880,  
TX760B-  
TX970B,  
760B

**OE Sanden SD7H15**  
Part # **509-560**



TEREX  
LOADER  
Models:  
SKL863,  
SKL873

**OE Sanden SD7H15**  
Part # **509-570**



TEREX  
CRAWLER  
Models:  
R20T

**Sanden SD7H13**  
Part # **509-5784**



24V

TEREX  
CRANE  
Models:  
T300-1

**Sanden SD7H15**  
Part # **509-5948**



TEREX  
TRUCK  
Models:  
TA25, TA30,  
TR70

**OE Sanden SD7H15**  
Part # **509-6004**

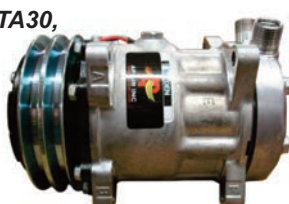

24V

TEREX  
TRUCK  
Models:  
TA300

**Sanden SD7H15**  
Part # **509-6624**



24V

## CAB INTERIOR

Kits & Replacement Parts

Replacement Interior Components for all Makes.



1-800-806-5312

TEREX & LINK-BELT



# TEREX & LINK-BELT

## Expansion Valves

### LINK-BELT EXCAVATOR

Models:  
330LX



Part # **903-705**

### LINK-BELT EXCAVATOR

Models:  
210LX



Part # **903-830**

### TEREX LOADER

Models:  
SKL863,  
SKL873



Part # **902-200**

### TEREX SKIDSTEER

Models:  
PT50, PT60,  
PT100



Part # **902-210**

### TEREX TRUCK

Models:  
TA25, TA30,  
TR70



Part # **903-727**

## Receiver Driers/Accumulators

### LINK-BELT EXCAVATOR

Models:  
130LX-460LX,  
800LX



Part # **803-450**

### TEREX SKIDSTEER

Models:  
PT50, PT60,  
PT100



Part # **800-8383**

### TEREX LOADER

Models:  
SKL863,  
SKL873



Part # **803-317**

### TEREX CRAWLER

Models:  
R20T



Part # **803-326**

### TEREX TRUCK

Models:  
TA25, TA30,  
TA70



Part # **803-328**

## Switches/Electrical

### Thermostatic Switch

TEREX LOADER  
Models:  
750-965,  
TX760B-  
TX970B



Part # **210-9631**

### Blower Speed Resistor

TEREX TRUCK  
Models:  
TA30

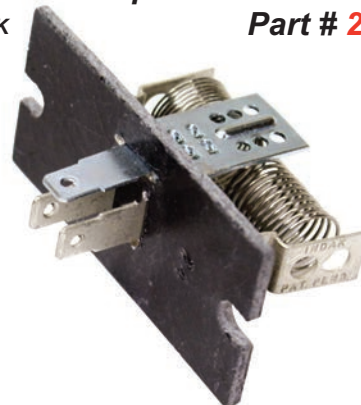

Part # **220-5274**



# VOLVO

## Blower Motors

Models:  
SL120-2

**WHEEL LOADER**

Part # **BM12414**



Models:  
4500

**WHEEL LOADER**

Part # **BM24215**



**TRUCK/WHEEL LOADER**

Models:  
A20-A35, L50,  
L70, L90,  
L120, L160

Part # **BM24217**

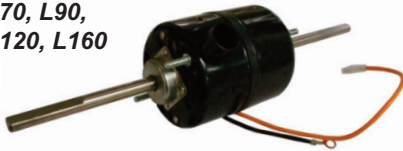

**BACKHOE**

Models:  
BL70

Part # **BM4007**



**TRUCK/EXCAVATOR/LOADER**

Models:  
A20C-  
A35D,  
L50E-  
L90C,  
EC280-  
EC420

Part # **BM4015-24V**



**WHEEL LOADER**

Models:  
L110F-L350F  
L70F-L90F

Part # **BM4061**



**TRUCK/EXCAVATOR/LOADER**

Models:  
A20-A40D,  
EC280-  
EC420,  
L110E-  
L330E,  
L30-L90E,  
180

Part # **BM4062**



**WHEEL LOADER**

Models:  
L60E, L70C

Part # **BM4065**



## Compressors

EXCAVATOR  
Models:  
EC55B

**V5 DAC/Daewoo**

Part # **502-078**



MOTOR  
GRADER  
Models:  
G720A,  
G720B,  
G740A,  
G740B

**Seltec TM-16HD**

Part # **506-784**

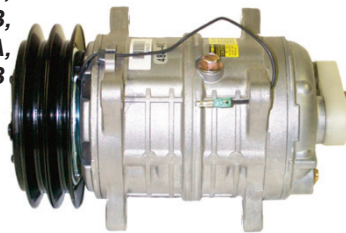

WHEEL  
LOADER  
Models:  
L50D

**Zexel DKS15CH**

Part # **506-859**



24V

24V

EXCAVATOR  
Models:  
ECR48C

**Sanden SD505**

Part # **509-394**



EXCAVATOR  
Models:  
A20-A35

**Sanden SD508**

Part # **509-4021**



24V

EXCAVATOR  
Models:  
A25C

**OE Sanden SD7H15**

Part # **509-4347**



24V

1-800-806-5312



# VOLVO

## Compressors

BACKHOE

Models:  
BL60, BL61,  
BL70

**OE Sanden SD7H15**

Part # **509-435**



WHEEL  
LOADER/TRUCK

Models: 180,  
A20C-A40,  
L120C,  
L150C,  
L70B-  
L90C

**OE Sanden SD5H14**

Part # **509-436**



24V

WHEEL  
LOADER

Models:  
L110E-  
L220D,  
L50E-  
L90E

**OE Sanden SD7H15**

Part # **509-6154**



24V

EXCAVATOR

Models:  
EC135BLC-  
EC360BLC,  
EW145B,  
FC2924C,  
FC3329C

**OE Sanden SD7H15**

Part # **509-6155**



24V

TRUCK/  
EXCAVATOR

Models:  
A25D-A40F,  
EC330B,  
EC460BLC

**OE Sanden SD7H15**

Part # **509-6188**



24V

## Condensers

TRUCK/LOADER

Models:  
A25C-A40C,  
L120, L150,  
L50-L90C

Part # **400-7500**



TRUCK/LOADER

Models:  
A25C-A40E,  
L110E-  
L330E,  
L50-L90E

Part # **400-7502**



WHEEL LOADER

Models:  
L110E-L350F,  
L25F-L90F

Part # **400-7504**

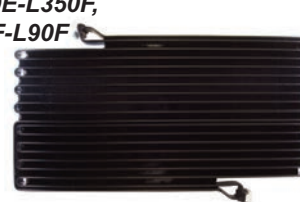

## Evaporators

TRUCK/LOADER

Models:  
A25C-A40D,  
L110E-  
L330E,  
L50-  
L90E

Part # **590-8502**

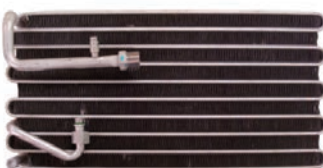

TRUCK/LOADER

Models:  
A25D-  
A40E,  
L60E-  
L90C

Part # **590-8504**

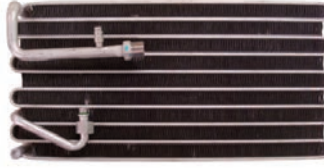

WHEEL LOADER

Models:  
L110E-  
L350F,  
L25F-  
L90F

Part # **590-8505**

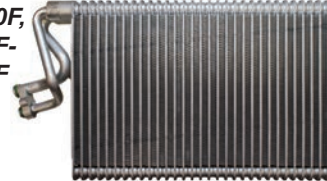

## Expansion Valves

WHEEL LOADER

Models:  
L50E, L70C,  
L90

Part # **902-200**



TRUCK/LOADER

Models:  
A25C-A40E,  
L110E-L330E,  
L70B-L90E

Part # **902-230**



EXCAVATOR

Models:  
EC135B-  
EC700B,  
EW145B-  
EW200B

Part # **903-762**



VOLVO



## Receiver Driers/Accumulators

VOLVO

### EXCAVATOR

Models:  
ECR48C

Part # **800-111**



### WHEEL LOADER

Models:  
L45B

Part # **800-8383**



### MOTOR GRADER

Models:  
87,  
G720A,  
G720B,  
G740A,  
G740B

Part # **803-337**



### LOADER/TRUCK

Models:  
180,  
A20,  
A35

Part # **803-347**



### ARTICULATED TRUCK

Models:  
A25, A25B

Part # **803-349**



### WHEEL LOADER

Models:  
L160

Part # **803-3496**



### WHEEL LOADER

Models:  
L70C

Part # **803-369**



### TRUCK/LOADER

Models:  
A20C-A40,  
L120C,  
L70B,  
L70C

Part # **803-3713**



### TRUCK/LOADER

Models:  
A25C,  
L120-L180C,  
L90, L90C

Part # **803-3714**



### TRUCK/LOADER

Models:  
A25D-A40E,  
L110E,  
L350F,  
L50D,  
L90F

Part # **803-401**



### EXCAVATOR

Models:  
ZX330LC

Part # **805-696**



## Switches/Electrical

### Binary Pressure Switch

TRUCK  
Models:  
A25C

Part # **220-1026**



### Blower Speed Resistor

LOADER  
Models:  
EC140B-  
EC460BLC

Part # **220-5294**

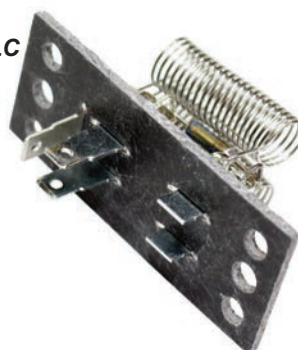

### Blower Speed Resistor

LOADER  
Models:  
180,  
L120E,  
L60E,  
L70E

Part # **220-5642**





# QUICK CLIP FITTINGS

## Quick Clip Assembly Instructions

1.



2.



3.



1. Place the two stainless clamps in the alignment grooves of the locator facing the same direction.

2. Slide the locator with clamps over the end of hose.

3. Slide fitting into hose until the collar of the fitting is firmly touching the locator. There is no oil needed for this procedure. Using the Quick Clip crimping plier (part # 530-8766), crimp the two stainless clamps until pliers are completely bottomed out.

Correctly crimped Quick Clip Fitting

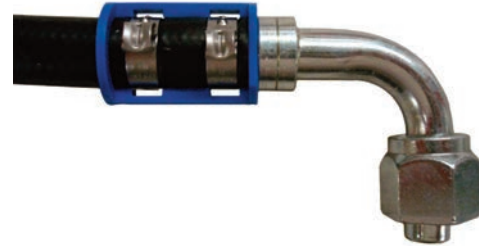

**Build your own O.E. hoses in half the time! No power required with AP Air's Quick Clip fittings! Our Quick Clip line gives you more versatility in shop, as well as the field. This crimping system requires no hydraulics, no power to operate, is reusable, and has virtually no crimp failure! Many O.E. Quick Clip fittings available. See [www.apairinc.com](http://www.apairinc.com) for specialty fittings for all brands!**

Blue Locator

#6 PART # 420-106



#8 PART # 420-108

#10 PART # 420-110

#12 PART # 420-112

Stainless Clamp

#6 PART # 420-006



#8 PART # 420-008

#10 PART # 420-0010

#12 PART # 420-0012

Part # 530-8766

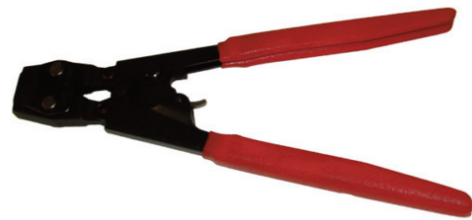

Quick Clip Crimping Pliers

Allows for quick, easy assembly of fittings and hose. Crimps all Quick Clip fittings on hose.

Part # 530-80013



Hose Cutter

Cuts up to 1 1/2" O.D. hose.

Part # 530-80113

Replacement Blade

Blade for 530-80013

**FOR OUR COMPLETE LINE OF A/C FITTINGS SEE US ON THE WEB!!**



# QUICK CLIP FITTINGS

QUICK CLIP FITTINGS

O-ring Fittings	Quick Clip	Reduced Diameter (Bead Lock)	Standard Diameter (Bead Lock)
<b>Straight Female O-ring</b> 	#6 <i>PART # <u>461-7525</u></i>	#6 <i>PART # <u>461-3525</u></i>	#6 <i>PART # <u>461-1525</u></i>
	#8 <i>PART # <u>461-7526</u></i>	#8 <i>PART # <u>461-3526</u></i>	#8 <i>PART # <u>461-1526</u></i>
	#10 <i>PART # <u>461-7527</u></i>	#10 <i>PART # <u>461-3527</u></i>	#10 <i>PART # <u>461-1527</u></i>
	#12 <i>PART # <u>461-7528</u></i>	#12 <i>PART # <u>461-3528</u></i>	#12 <i>PART # <u>461-1528</u></i>
<b>45° Female O-ring</b> 	#6 <i>PART # <u>461-7529</u></i>	#6 <i>PART # <u>461-3529</u></i>	#6 <i>PART # <u>461-1529</u></i>
	#8 <i>PART # <u>461-7530</u></i>	#8 <i>PART # <u>461-3530</u></i>	#8 <i>PART # <u>461-1530</u></i>
	#10 <i>PART # <u>461-7531</u></i>	#10 <i>PART # <u>461-3531</u></i>	#10 <i>PART # <u>461-1531</u></i>
	#12 <i>PART # <u>461-7532</u></i>	#12 <i>PART # <u>461-3532</u></i>	#12 <i>PART # <u>461-1532</u></i>
<b>90° Female O-ring</b> 	#6 <i>PART # <u>461-7533</u></i>	#6 <i>PART # <u>461-3533</u></i>	#6 <i>PART # <u>461-1533</u></i>
	#8 <i>PART # <u>461-7534</u></i>	#8 <i>PART # <u>461-3534</u></i>	#8 <i>PART # <u>461-1534</u></i>
	#10 <i>PART # <u>461-7535</u></i>	#10 <i>PART # <u>461-3535</u></i>	#10 <i>PART # <u>461-1535</u></i>
	#12 <i>PART # <u>461-7536</u></i>	#12 <i>PART # <u>461-3536</u></i>	#12 <i>PART # <u>461-1536</u></i>
<b>Straight Male O-ring</b> 	#6 <i>PART # <u>461-7537</u></i>	#6 <i>PART # <u>461-3537</u></i>	#6 <i>PART # <u>461-1537</u></i>
	#8 <i>PART # <u>461-7538</u></i>	#8 <i>PART # <u>461-3538</u></i>	#8 <i>PART # <u>461-1538</u></i>
	#10 <i>PART # <u>461-7539</u></i>	#10 <i>PART # <u>461-3539</u></i>	#10 <i>PART # <u>461-1539</u></i>
	#12 <i>PART # <u>461-7540</u></i>	#12 <i>PART # <u>461-3540</u></i>	#12 <i>PART # <u>461-1540</u></i>
<b>45° Male O-ring</b> 	#6 <i>PART # <u>461-7541</u></i>	#6 <i>PART # <u>461-3541</u></i>	#6 <i>PART # <u>461-1541</u></i>
	#8 <i>PART # <u>461-7542</u></i>	#8 <i>PART # <u>461-3542</u></i>	#8 <i>PART # <u>461-1542</u></i>
	#10 <i>PART # <u>461-7543</u></i>	#10 <i>PART # <u>461-3543</u></i>	#10 <i>PART # <u>461-1543</u></i>
	#12 <i>PART # <u>461-7544</u></i>	#12 <i>PART # <u>461-3544</u></i>	#12 <i>PART # <u>461-1544</u></i>
<b>90° Male O-ring</b> 	#6 <i>PART # <u>461-7545</u></i>	#6 <i>PART # <u>461-3545</u></i>	#6 <i>PART # <u>461-1545</u></i>
	#8 <i>PART # <u>461-7546</u></i>	#8 <i>PART # <u>461-3546</u></i>	#8 <i>PART # <u>461-1546</u></i>
	#10 <i>PART # <u>461-7547</u></i>	#10 <i>PART # <u>461-3547</u></i>	#10 <i>PART # <u>461-1547</u></i>
	#12 <i>PART # <u>461-7548</u></i>	#12 <i>PART # <u>461-3548</u></i>	#12 <i>PART # <u>461-1548</u></i>

1-800-806-5312



# QUICK CLIP FITTINGS

## Straight Female O-ring

Stepped



Fitting Size	Hose Size	Part Number
#6	#8	<a href="#"><u>461-7726</u></a>
#10	#12	<a href="#"><u>461-7728</u></a>
#8	#6	<a href="#"><u>461-7729</u></a>
#12	#10	<a href="#"><u>461-7731</u></a>

## Straight Female O-ring

R134 Charge Port



Fitting Size	Hose Size	Part Number
#6	#6	<a href="#"><u>461-7925</u></a>
#8	#8	<a href="#"><u>461-7926</u></a>
#10	#10	<a href="#"><u>461-7927</u></a>
#10	#12	<a href="#"><u>461-7928</u></a>
#12	#12	<a href="#"><u>461-7929</u></a>

## Straight Female O-ring

R12/Switch Port



Fitting Size	Hose Size	Part Number
#6	#6	<a href="#"><u>461-7625</u></a>
#8	#8	<a href="#"><u>461-7626</u></a>
#10	#10	<a href="#"><u>461-7627</u></a>

## Straight Tube O-ring

R134 Charge Port



Fitting Size	Hose Size	Part Number
Tube O-ring	#8	<a href="#"><u>461-7402</u></a>
Tube O-ring	#10	<a href="#"><u>461-7403</u></a>
Tube O-ring	#12	<a href="#"><u>461-7404</u></a>

## 45° Female O-ring

Stepped



Fitting Size	Hose Size	Part Number
#10	#12	<a href="#"><u>461-7734</u></a>

## 45° Female O-ring

R134 Charge Port



Fitting Size	Hose Size	Part Number
#8	#8	<a href="#"><u>461-7930</u></a>
#10	#10	<a href="#"><u>461-7931</u></a>
#10	#12	<a href="#"><u>461-7932</u></a>

## 45° Female O-ring

R12/Switch Port



Fitting Size	Hose Size	Part Number
#6	#6	<a href="#"><u>461-7629</u></a>
#8	#8	<a href="#"><u>461-7630</u></a>
#10	#10	<a href="#"><u>461-7631</u></a>

## 45° Tube O-ring

R134 Charge Port



Fitting Size	Hose Size	Part Number
Tube O-ring	#8	<a href="#"><u>451-7132</u></a>
Tube O-ring	#10	<a href="#"><u>451-7133</u></a>
Tube O-ring	#12	<a href="#"><u>451-7134</u></a>

## 90° Female O-ring

Stepped



Fitting Size	Hose Size	Part Number
#6	#8	<a href="#"><u>461-7735</u></a>
#8	#10	<a href="#"><u>461-7736</u></a>
#10	#12	<a href="#"><u>461-7737</u></a>
#8	#6	<a href="#"><u>461-7738</u></a>
#12	#10	<a href="#"><u>461-7739</u></a>

## 90° Female O-ring

R134 Charge Port



Fitting Size	Hose Size	Part Number
#6	#6	<a href="#"><u>461-7933</u></a>
#8	#8	<a href="#"><u>461-7934</u></a>
#10	#10	<a href="#"><u>461-7935</u></a>
#10	#12	<a href="#"><u>461-7936</u></a>
#12	#12	<a href="#"><u>461-7937</u></a>

## 90° Female O-ring

R12/Switch Port



Fitting Size	Hose Size	Part Number
#6	#6	<a href="#"><u>461-7633</u></a>
#8	#8	<a href="#"><u>461-7634</u></a>
#10	#10	<a href="#"><u>461-7635</u></a>
#10	#12	<a href="#"><u>461-7637</u></a>

## 90° Tube O-ring

R134 Charge Port



Fitting Size	Hose Size	Part Number
Tube O-ring	#8	<a href="#"><u>451-7129</u></a>
Tube O-ring	#10	<a href="#"><u>451-7130</u></a>
Tube O-ring	#12	<a href="#"><u>451-7131</u></a>

## Straight Male O-ring

Stepped



Fitting Size	Hose Size	Part Number
#10	#12	<a href="#"><u>461-7742</u></a>

## Straight Male O-ring

R134 Charge Port



Fitting Size	Hose Size	Part Number
#10	#12	<a href="#"><u>451-7940</u></a>
#10	#10	<a href="#"><u>461-7939</u></a>

## 90° Male O-ring

Stepped



Fitting Size	Hose Size	Part Number
#10	#12	<a href="#"><u>461-7751</u></a>

## 90° Male O-ring

R134 Charge Port



Fitting Size	Hose Size	Part Number
#8	#8	<a href="#"><u>461-7946</u></a>
#10	#10	<a href="#"><u>461-7947</u></a>

## Straight Male Ins. O-ring



Fitting Size	Hose Size	Part Number
#6	#6	<a href="#"><u>461-7549</u></a>
#8	#8	<a href="#"><u>461-7550</u></a>
#10	#10	<a href="#"><u>461-7551</u></a>
#12	#12	<a href="#"><u>461-7552</u></a>
#10	#12	<a href="#"><u>461-7757</u></a>

## 45° Male Insert O-ring



Fitting Size	Hose Size	Part Number
#6	#6	<a href="#"><u>461-7553</u></a>
#8	#8	<a href="#"><u>461-7554</u></a>
#10	#10	<a href="#"><u>461-7555</u></a>
#12	#12	<a href="#"><u>461-7556</u></a>

## 90° Male Insert O-ring



Fitting Size	Hose Size	Part Number
#6	#6	<a href="#"><u>461-7557</u></a>
#8	#8	<a href="#"><u>461-7558</u></a>
#10	#10	<a href="#"><u>461-7559</u></a>
#12	#12	<a href="#"><u>461-7560</u></a>
#10	#12	<a href="#"><u>461-7763</u></a>

## 90° Male O-ring

R12/Switch Port



Fitting Size	Hose Size	Part Number
#6	#6	<a href="#"><u>461-7645</u></a>
#10	#12	<a href="#"><u>461-7653</u></a>



# FLEX REPAIR FITTINGS

**FLEX REPAIR FITTINGS**

## Flex Hold Down Plate

6mm/8mm  
Center Bolt



Part Number  
**451-11901**

Use with fittings below...

## Flex Hold Down Plate

8mm/10mm  
Center Bolt



Part Number  
**451-11902**

Use with fittings below...

AP Air's "Flex Fitting" line-up is a must for any service truck. Our fitting adapters are suited for all makes of heavy duty equipment.

With AP Air's Flex Fittings technicians are able to adapt common 6, 8 & 10 female o-ring fittings with great Flexibility!



Cond/Exp. Valve	Comp/Cond/Exp. Valve	Comp/Exp. Valve	Cond/Exp. Valve
-----------------	----------------------	-----------------	-----------------

 #6MIO #6 O-ring or Sealing Washer	 #8MIO	 #10MIO #10 O-ring or Sealing Washer	 #6MIO #6 O-ring																																				
<table border="1" style="width: 100%; border-collapse: collapse;"> <tr> <th>Fitting Size</th> <th>Pilot Size</th> <th>Part Number</th> </tr> <tr> <td>#6MIO</td> <td>#6 0.334"</td> <td><b>451-11903</b></td> </tr> <tr> <td>Block Off</td> <td>#6 0.334"</td> <td><b>451-119031</b></td> </tr> </table>	Fitting Size	Pilot Size	Part Number	#6MIO	#6 0.334"	<b>451-11903</b>	Block Off	#6 0.334"	<b>451-119031</b>	<table border="1" style="width: 100%; border-collapse: collapse;"> <tr> <th>Fitting Size</th> <th>Pilot Size</th> <th>Part Number</th> </tr> <tr> <td>#8MIO</td> <td>#8 0.464"</td> <td><b>451-11904</b></td> </tr> <tr> <td>Block Off</td> <td>#8 0.464"</td> <td><b>451-119041</b></td> </tr> </table>	Fitting Size	Pilot Size	Part Number	#8MIO	#8 0.464"	<b>451-11904</b>	Block Off	#8 0.464"	<b>451-119041</b>	<table border="1" style="width: 100%; border-collapse: collapse;"> <tr> <th>Fitting Size</th> <th>Pilot Size</th> <th>Part Number</th> </tr> <tr> <td>#10MIO</td> <td>#10 0.564"</td> <td><b>451-11905</b></td> </tr> <tr> <td>Block Off</td> <td>#10 0.564"</td> <td><b>451-119051</b></td> </tr> </table>	Fitting Size	Pilot Size	Part Number	#10MIO	#10 0.564"	<b>451-11905</b>	Block Off	#10 0.564"	<b>451-119051</b>	<table border="1" style="width: 100%; border-collapse: collapse;"> <tr> <th>Fitting Size</th> <th>Pilot Size</th> <th>Part Number</th> </tr> <tr> <td>#6MIO</td> <td>#6 0.334"</td> <td><b>451-11906</b></td> </tr> <tr> <td>Block Off</td> <td>#6 0.334"</td> <td><b>451-119061</b></td> </tr> </table>	Fitting Size	Pilot Size	Part Number	#6MIO	#6 0.334"	<b>451-11906</b>	Block Off	#6 0.334"	<b>451-119061</b>
Fitting Size	Pilot Size	Part Number																																					
#6MIO	#6 0.334"	<b>451-11903</b>																																					
Block Off	#6 0.334"	<b>451-119031</b>																																					
Fitting Size	Pilot Size	Part Number																																					
#8MIO	#8 0.464"	<b>451-11904</b>																																					
Block Off	#8 0.464"	<b>451-119041</b>																																					
Fitting Size	Pilot Size	Part Number																																					
#10MIO	#10 0.564"	<b>451-11905</b>																																					
Block Off	#10 0.564"	<b>451-119051</b>																																					
Fitting Size	Pilot Size	Part Number																																					
#6MIO	#6 0.334"	<b>451-11906</b>																																					
Block Off	#6 0.334"	<b>451-119061</b>																																					

Comp/Cond/Exp. Valve	Comp/Exp. Valve	H6 GM Compressor	H6 GM Compressor
----------------------	-----------------	------------------	------------------

 #8MIO #8 O-ring	 #10MIO #10 O-ring	 #8MIO #12 O-ring or Sealing Washer	 #10MIO #12 O-ring or Sealing Washer																														
<table border="1" style="width: 100%; border-collapse: collapse;"> <tr> <th>Fitting Size</th> <th>Pilot Size</th> <th>Part Number</th> </tr> <tr> <td>#8MIO</td> <td>#8 0.464"</td> <td><b>451-11907</b></td> </tr> <tr> <td>Block Off</td> <td>#8 0.464"</td> <td><b>451-119071</b></td> </tr> </table>	Fitting Size	Pilot Size	Part Number	#8MIO	#8 0.464"	<b>451-11907</b>	Block Off	#8 0.464"	<b>451-119071</b>	<table border="1" style="width: 100%; border-collapse: collapse;"> <tr> <th>Fitting Size</th> <th>Pilot Size</th> <th>Part Number</th> </tr> <tr> <td>#10MIO</td> <td>#10 0.564"</td> <td><b>451-11908</b></td> </tr> <tr> <td>Block Off</td> <td>#10 0.564"</td> <td><b>451-119081</b></td> </tr> </table>	Fitting Size	Pilot Size	Part Number	#10MIO	#10 0.564"	<b>451-11908</b>	Block Off	#10 0.564"	<b>451-119081</b>	<table border="1" style="width: 100%; border-collapse: collapse;"> <tr> <th>Fitting Size</th> <th>Pilot Size</th> <th>Part Number</th> </tr> <tr> <td>#8MIO</td> <td>#12 0.625"</td> <td><b>451-11909</b></td> </tr> </table>	Fitting Size	Pilot Size	Part Number	#8MIO	#12 0.625"	<b>451-11909</b>	<table border="1" style="width: 100%; border-collapse: collapse;"> <tr> <th>Fitting Size</th> <th>Pilot Size</th> <th>Part Number</th> </tr> <tr> <td>#10MIO</td> <td>#12 0.625"</td> <td><b>451-11910</b></td> </tr> </table>	Fitting Size	Pilot Size	Part Number	#10MIO	#12 0.625"	<b>451-11910</b>
Fitting Size	Pilot Size	Part Number																															
#8MIO	#8 0.464"	<b>451-11907</b>																															
Block Off	#8 0.464"	<b>451-119071</b>																															
Fitting Size	Pilot Size	Part Number																															
#10MIO	#10 0.564"	<b>451-11908</b>																															
Block Off	#10 0.564"	<b>451-119081</b>																															
Fitting Size	Pilot Size	Part Number																															
#8MIO	#12 0.625"	<b>451-11909</b>																															
Fitting Size	Pilot Size	Part Number																															
#10MIO	#12 0.625"	<b>451-11910</b>																															

CAT. Straight Pad Fitting	CAT. Straight Pad Fitting
---------------------------	---------------------------

 #8MIO <b>451-1141</b> High Side R134a	 #10MIO <b>451-1142</b> Low Side R134a
--	---

## A/C FLUSHING MACHINE

Part # **530-1100**



- Removes debris and contaminants from AC Systems.
- Restores performance of AC System by removing carbon build up from heat transfer.
- Powered by shop air.
- Forward or reverse flush without charging hoses.
- Easy to connect quick couplers - fit evaporators, condensers, and hose connections.
- 8ft clear braided hoses.

**1-800-806-5312**



# FLEX COMPRESSORS

## Universal Sanden Compressor Program

### Benefits of FLX7 Compressor Program...

- **Reduced Inventory-** Stock one compressor which covers hundreds of models. Use any of the combinations below to fit your application.
- **Added Value** -each FLX7 comes equipped with heavy duty clutch, bearings & clutch diode for superior durability.
- **#1 O.E.M. Choice** -Sanden compressors have become original equipment for manufacturers around the world.



12V Part # **509-578**  
24V Part # **509-5784**

SD7H15, FLX7, 6  
1/4" Single Groove  
Clutch, Pad Mount

Horizontal Tube  
O-Ring 1" x 14

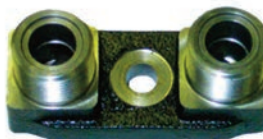

Part # **451-1150**

Horizontal 8 x 10  
O-Ring



Part # **451-1153**



12V Part # **509-571**  
24V Part # **509-5714**

SD7H15, FLX7, 5  
1/4" 2 Groove  
Clutch, Pad Mount

Vertical Tube  
O-Ring 1" x 14



Part # **451-1152**

Vertical 8 x 10  
O-Ring



Part # **451-1151**

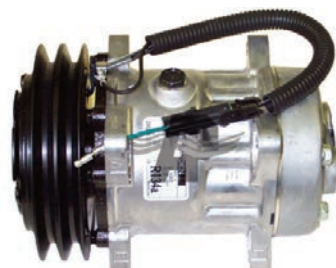

12V Part # **509-576**

SD7H15, FLX7, 6" 2  
Groove Clutch, Pad  
Mount



Converts 8 x 10 Male  
O-Ring to Male Flare

Part # **460-1367**

## Universal Service Valve Program

### Multi-Port Service Valve Kit



12V Part # **451-6050K**

### Kit Includes...

- \*8 x 10 O-ring Service Valves
- \*Tube O-ring Service Valves
- \*R12 Adapter
- \*10mm Adapter
- \*12mm Adapter
- \*R134a Low Side Adapter
- \*R134a High Side Adapter
- \*8 x 10 Flare Adapters
- \*High Pressure Relief Valve

### New Universal Flex Service Valve Kit

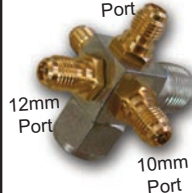

Available in 8 x 10 O-ring, and Tube  
O-ring. Use with any of our switch/charge  
port adapters to fit your needs!

R12 Switch Port Part # **461-3126**

10mm Switch Port Part # **461-3125**

12mm Switch Port Part # **461-3124**

### Tube O-ring Service Valve Kit



Part # **451-6045**

### 8 x 10 O-ring Service Valve Kit



Part # **451-6001**



# FLEX DRIERS

## Universal Sanden Compressor Program

2 1/2" x 8" Male O-ring

Part # 800-8281



2 1/2" x 8" Male To Female O-ring

Part # 800-8282



3" x 6" Male O-ring

Part # 800-8361



3" x 8" Male O-ring

Part # 800-8383



3" x 10" Male O-ring

Part # 800-8384



3" x 8" Male To Female O-ring

Part # 800-8394



3" x 10" Male To Female O-ring

Part # 800-8395



3" x 10" Female To Male O-ring

Part # 800-8396



3" x 10" Female To Female O-ring

Part # 800-8399

**IH Truck**



FLEX Charge Port Adapter/Fitting Kit

Includes:



Part # 451-6070K

AP Air's NEW Universal Flex Drier program eliminates over 50 individual part numbers! Build hundreds of combinations with the 9 Flex Driers and our assortment of Flex Adapters.

FLEX DRIERS



# RED DOT/FREON

**AP Air Inc. is your Authorized Red DOT Dealer.  
View our other Red Dot Products at**

**[www.apairinc.com](http://www.apairinc.com)**



Dash Mount A/C Unit 12V & 24V



Part # 590-92112  
Part # 590-92124



Defrost/Sleeper Fan 12V  
Part # **BM11000**



Headliner Mount  
Evaporator A/C Unit 12V & 24V  
Part # 590-61009  
Part # 590-61010



Backwall A/C Unit 12V & 24V  
Part # 590-6830-12  
Part # 590-6830-24



Roof Mount A/C Unit 12V & 24V  
Part # 590-6100-12  
Part # 590-6100-24

## R134a Freon

USA Made  
Dupont or Honeywell  
R134a Refrigerant



30lb cyl. Part # 520-218

Dupont, Honeywell  
or National  
R134a Refrigerant



12oz. Part # 520-6312  
(60) 12oz. cans Part # 520-6312-60

Arctic Edge  
R134a Refrigerant



Part # 520-217



# UNIVERSAL HEATERS

7 1/2" x 7" x 4 1/2" 12 Volt, 4 Blade  
Compact Fan, Universal Heater



*With Directional  
Louvers*

Specifications:

Thickness/Depth- 4 1/2"

Height- 7"

Width- 7 1/2"

Fitting Inlet- 5/8"

Fitting Outlet- 5/8"

Voltage- 12

**Part # AH1122**  
w/o Louvers & Defrost

**Part # AH1123**  
w/o Defrost

**Part # AH1124**  
w/ Defrost

UNIVERSAL/UTV HEATERS

## 2013-2016 **RANGER**

Fits: Polaris Ranger XP 900



**Part # AH355**

*With Defrost*



**APPLICATIONS FOR:**

**Arctic Cat, Can-AM, Honda, John Deere,  
Kawasaki, Polaris, Yamaha**

**1-800-806-5312**



**AP Air Inc.**  
**805 13th Street North**  
**Humboldt, IA 50548**  
**Email: sales@apairinc.com**

**Look Inside For:**  
**A/C Supplies**  
**Blower Motors**  
**Compressors**  
**Condensers**  
**Evaporators**  
**Fan Clutches**  
**Freon**  
**Heater Cores**  
**Hoses/Lines**  
**Oil, Flush**  
**O-Rings/Gaskets**  
**Radiators**  
**Receiver Driers**  
**Red Dot Units**  
**Sanden Kits**  
**Switches**



**1-800-806-5312**

**www.apairinc.com**

We Accept

